

HistoCore PEGASUS Plus

Tissue Processor



Instructions for Use
English

Order No.: 14 0488 80101 - Revision L

Always keep this manual with the instrument.
Read carefully before working with the instrument.

CE

The information, numerical data, notes and value judgments contained in this Instructions for Use represent the current state of scientific knowledge and state-of-the-art technology as we understand it following thorough investigation in this field.

We are under no obligation to update the present Instructions for Use periodically and on an ongoing basis according to the latest technical developments, nor to provide our customers with additional copies, updates etc. of this Instructions for Use.

To the extent permitted in accordance with the national legal system as applicable in each individual case, we shall not be held liable for erroneous statements, drawings, technical illustrations etc. contained in this Instructions for Use. In particular, no liability whatsoever is accepted for any financial loss or consequential damage caused by or related to compliance with statements or other information in this Instructions for Use.

Statements, drawings, illustrations and other information regarding the contents or technical details of the present Instructions for Use are not to be considered warranted characteristics of our products.

These are determined only by the contract provisions agreed between ourselves and our customers.

Leica reserves the right to change technical specifications as well as manufacturing processes without prior notice. Only in this way is it possible to continuously improve the technology and manufacturing techniques used in our products.

This document is protected under copyright laws. All copyrights to this documentation are held by Leica Biosystems Nussloch GmbH.

Any reproduction of text and illustrations (or of any parts thereof) by means of print, photocopy, microfiche, web cam or other methods – including any electronic systems and media – requires express prior permission in writing by Leica Biosystems Nussloch GmbH.

For the instrument serial number and year of manufacture, please refer to the nameplate on the back of the instrument.



Leica Biosystems Nussloch GmbH
Heidelberger Strasse 17 - 19
69226 Nussloch
Germany
Tel.: +49 - (0) 6224 - 143 0
Fax: +49 - (0) 6224 - 143 268
Web: www.LeicaBiosystems.com

Assembly contracted to Leica Microsystems Ltd. Shanghai

Table of Contents

1. Important Information	8
1.1 Naming conventions	8
1.2 Symbols and their meanings.....	8
1.3 Instrument type	12
1.4 Intended purpose.....	12
1.5 Qualification of personnel	12
1.6 Statement for user data security and privacy.....	12
2. Safety.....	13
2.1 Safety notes	13
2.1.1 Dos and Don'ts.....	14
2.2 Warnings	14
2.2.1 Markings on the instrument itself	15
2.2.2 Transport and installation.....	15
2.2.3 Operating the instrument.....	17
2.2.4 Handling reagents.....	24
2.3 Safety features on the instrument	25
3. Instrument Components and Specifications	26
3.1 Overview	26
3.1.1 Instrument components	26
3.1.2 Rear panel	27
3.2 Main features of the instrument.....	27
3.3 Technical data	28
4. Setting up the Instrument	31
4.1 Installation site requirements	31
4.2 Standard delivery - packing list	31
4.3 Unpacking and installation	33
4.3.1 Unpacking Instructions.....	33
4.3.2 Installing the display	36
4.3.3 Active carbon filter.....	36
4.3.4 External exhaust system	37
4.4 Basic instrument/hardware	38
4.4.1 Retorts	38
4.4.2 Cassette baskets	42
4.4.3 Paraffin baths	44
4.4.4 Reagent cabinet.....	45
4.4.5 Drip tray	47
4.4.6 Display	48
4.4.7 HistoCore I-Scan.....	49
4.4.8 USB ports	50
4.4.9 Alarm connections.....	51
4.5 Connecting an uninterruptible power supply (UPS).....	52
4.6 Switching on and off	53
4.6.1 Switching on.....	53
4.6.2 Switching off	54
4.6.3 Emergency shutdown.....	54
4.6.4 Restart after long time shutdown.....	54
4.7 Moving the instrument	55

5.	Running Protocol	56
5.1	Using the software.....	56
5.1.1	Basic operation.....	56
5.1.2	Navigation.....	57
5.1.3	Access levels.....	59
5.1.4	Help.....	61
5.2	Quick start.....	61
5.3	Cleaning protocols.....	68
5.4	Status screen.....	72
5.4.1	Status area.....	73
5.4.2	Protocol panels.....	77
5.5	Protocol run options.....	80
5.5.1	Scheduling protocols.....	80
5.5.2	Changing the starting step for a single run.....	82
5.5.3	Changing the step time for a single run.....	83
5.6	Pausing and aborting protocols.....	85
5.6.1	Recovering from an aborted run.....	87
5.7	Retort scheduling.....	87
5.7.1	Delayed end times and initial fills.....	88
5.7.2	Unavoidable reagent clashes.....	88
5.7.3	Unavailable reagents.....	88
6.	Protocol Setup	90
6.1	Protocol overview.....	90
6.1.1	Protocol types.....	90
6.1.2	Reagent selection method.....	91
6.1.3	Pre-defined protocols.....	92
6.1.4	Protocol validation.....	93
6.1.5	Carryover setting 93	
6.1.6	Protocol files.....	96
6.2	Creating, editing, and viewing protocols.....	96
6.2.1	Protocol selection screen.....	96
6.2.2	Editing protocols.....	96
6.2.3	Creating new protocols.....	99
6.2.4	Viewing protocols.....	102
7.	Reagent Setup	103
7.1	Overview.....	103
7.1.1	Reagent groups, types, and stations.....	103
7.1.2	Concentration management.....	105
7.1.3	Thresholds.....	106
7.1.4	Recommended reagents.....	109
7.1.5	Non-recommended reagents.....	111
7.1.6	Reagent compatibility.....	111
7.2	Managing reagent types.....	112
7.2.1	Pre-defined reagents.....	112
7.2.2	Editing active reagent types.....	112
7.2.3	Adding, hiding, and deleting reagents.....	115
7.3	Managing reagent stations.....	117
7.3.1	Reagent stations screen.....	118

Table of Contents

7.3.2	Setting reagent station properties	119
7.4	Replacing reagents	122
7.4.1	Remote fill/drain screen	122
7.4.2	Remote fill/drain connections	123
7.4.3	Replacing reagent – remote fill and drain	124
7.4.4	Replacing reagent – Manually	127
7.4.5	Replacing paraffin	128
7.4.6	Filling and draining retorts	130
8.	Ancillary Settings & Operations	131
8.1	Reagents menu	131
8.1.1	Manual operations	131
8.2	Administration menu	132
8.2.1	User management	133
8.2.2	Reports	134
8.2.3	Event logs	138
8.3	Settings menu	139
8.3.1	Service	139
8.3.2	Processing settings	141
8.3.3	Instrument settings	143
8.3.4	Tracking options	146
9.	Cleaning and Maintenance	148
9.1	Cleaning and maintenance tools	148
9.1.1	Paraffin scraper	148
9.1.2	Level sensor brush	148
9.1.3	Paraffin bath vent plug	149
9.2	Maintenance screen	149
9.3	Cleaning and maintenance schedule	150
9.3.1	Daily Tasks	152
9.3.2	Weekly tasks	157
9.3.3	60–90 Days	159
10.	Reference	161
10.1	Reagent threshold guidelines	161
10.2	Protocols	162
10.2.1	Specimen type and protocol duration	162
10.2.2	List of pre-defined protocols	162
10.2.3	Xylene protocols	163
10.2.4	Cleaning protocol	166
10.3	Station configurations	166
10.4	Protocol Step temperatures	169
10.5	Reagent compatibility tables	169
11.	Troubleshooting	172
11.1	Preliminary questions	172
11.2	Flowcharts	172
11.2.1	Under-processed tissue – Instrument Setup	173
11.2.2	Over-processed tissue – Instrument Setup	174
11.2.3	Under- or Over-processed issue – Reagents	175
11.2.4	Poor processing – Incorrect protocol	176
11.2.5	Poor processing – Correct protocol	177
11.2.6	Cutting artifact	178

Table of Contents

11.2.7 Staining artifact	179
11.2.8 Block artifact	180
11.2.9 Reprocessing recommendations	181
11.3 Power failure	184
11.4 Crash or freeze of master software	184
12. Ordering Information.....	185
A1. Decontamination Confirmation	186
A2. Warranty and Service	187

1. Important Information

1.1 Naming conventions



Note

- The full name of the device is HistoCore PEGASUS Plus tissue processor. The device is called HistoCore PEGASUS Plus to ensure that the Instructions for Use are well legible.

1.2 Symbols and their meanings

Symbol:



Title of the symbol: Danger

Description: Indicates an imminently hazardous situation which, if not avoided, will result in death or serious injuries.

Symbol:



Title of the symbol: Warning

Description: If this danger is not avoided, then this may result in death or serious injury.

Symbol:



Title of the symbol: Caution

Description: Indicates a potentially hazardous situation which, if not avoided, could result in death or serious injury.

Symbol:



Title of the symbol: Note

Description: Indicates information which is important but not related to any risk.

Symbol:

→ Fig. 7-1

Title of the symbol: Item number

Description: Item numbers for numbering illustrations. Numbers in red refer to item numbers in illustrations.

Symbol:

Supervisor

Title of the symbol: Software designations

Description: Software designations that have to be displayed on the input screen are displayed as bold, gray text.

Symbol:

Save

Title of the symbol: Function key

Description: Function keys to be pressed on the instrument are displayed as bold, gray and underlined text.

Symbol:

Power switch

Title of the symbol: Keys and switches on the instrument











Description: Keys and switches on the instrument that are supposed to be pressed by the user in various situations are displayed as bold, gray and underlined text.





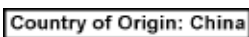





Symbol:



Title of the symbol: Manufacturer

Description: Indicates the manufacturer of the medical product.

<p>Symbol:</p> 	<p>Title of the symbol: Manufacturing date</p> <p>Description: Indicates the date when the medical device was manufactured.</p>
<p>Symbol:</p> 	<p>Title of the symbol: Article number</p> <p>Description: Indicates the manufacturer's catalog number so that the medical device can be identified.</p>
<p>Symbol:</p> 	<p>Title of the symbol: Serial number</p> <p>Description: Indicates the manufacturer's serial number so that a specific medical device can be identified.</p>
<p>Symbol:</p> 	<p>Title of the symbol: Consult Instructions for Use</p> <p>Description: Indicates the need for the user to consult the Instructions for Use.</p>
<p>Symbol:</p> 	<p>Title of the symbol: Attention</p> <p>Description: Indicates the need for the user to consult the Instructions for Use for important cautionary information such as warnings and precautions that cannot, for a variety of reasons, be presented on the medical device itself.</p>
<p>Symbol:</p> 	<p>Title of the symbol: In vitro diagnostic medical device</p> <p>Description: Indicates a medical device that is intended to be used as an in vitro diagnostic medical device.</p>
<p>Symbol:</p> 	<p>Title of the symbol: CE Compliance</p> <p>Description: The CE marking is the manufacturer's declaration that the medical product meets the requirements of the applicable EC directives and regulations.</p>
<p>Symbol:</p> 	<p>Title of the symbol: Country of Origin</p> <p>Description: The Country of Origin box defines the Country where the final character transformation of the product has been performed.</p>
<p>Symbol:</p> 	<p>Title of the symbol: UKCA</p> <p>Description: The UKCA (UK Conformity Assessed) marking is a new UK product marking that is used for goods being placed on the market in Great Britain (England, Wales and Scotland). It covers most goods which previously required the CE marking.</p>
<p>Symbol:</p> 	<p>Title of the symbol: UKRP</p> <p>Description: The UK Responsible Person acts on behalf of the non-UK manufacturer to carry out specified tasks in relation to the manufacturer's obligations.</p>
<p>Symbol:</p> 	<p>Title of the symbol: WEEE Symbol</p> <p>Description: The WEEE symbol, indicating separate collection for WEEE – Waste of electrical and electronic equipment, consists of the crossed-out wheeled bin (§ 7 ElektroG).</p>

Symbol:		Title of the symbol: China ROHS
		Description: Environmental protection symbol of the China RoHS directive. The number in the symbol indicates the "Environment-friendly Use Period" of the product in years. The symbol is used if a substance restricted in China is used in excess of the maximum permitted limit.
Symbol:		Title of the symbol: Alternating current
Symbol:		Title of the symbol: PE terminal
Symbol:		Title of the symbol: ON (Power)
		Description: In the position of power on
Symbol:		Title of the symbol: OFF (Power)
		Description: In the position of power off
Symbol:		Title of the symbol: Warning, hot surface
		Description: Instrument surfaces which become hot during operation are marked with this symbol. Avoid direct contact to prevent the risk of burning.
Symbol:		Title of the symbol: Biohazard warning
		Description:
Symbol:		Title of the symbol: Flammable
		Description: Flammable reagents, solvents, and cleaning agents are labeled with this symbol.
Symbol:		Title of the symbol: Fragile, handle with care
		Description: The package contents are fragile and must be handled with care.
Symbol:		Title of the symbol: Store dry
		Description: The package must be kept in a dry environment.

Symbol:



Title of the symbol: Stack limit
Description: Do not stack.

Symbol:



Title of the symbol: This way up
Description: Indicates the correct upright position of the package.

Symbol:

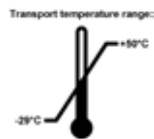

Title of the symbol: Temperature limit for transport
Description: Indicates the temperature range permitted for transporting the package.

Symbol:

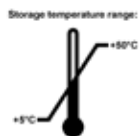

Title of the symbol: Temperature limit for storage
Description: Indicates the temperature range permitted for storing the package.

Symbol:

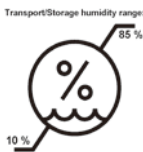

Title of the symbol: Humidity limitation for transport and storage
Description: Indicates the humidity range permitted for storing and transporting the package.

Symbol:



Title of the symbol: Shockdot Impact Indicator
Description: In the Shockwatch system, the shock dot shows impacts or shocks that are above a specified intensity through red colouration. Exceeding a defined acceleration (g value) causes the indicator tube to change colour.

Symbol:



Title of the symbol: Tilt indicator
Description: Tip-n-Tell indicator to monitor whether the shipment has been transported and stored in an upright position according to your requirements. With a pitch of 60° or more, the blue quartz sand flows into the arrow-shaped indicator window and sticks there permanently. Improper handling of the shipment is immediately detectable and can be proven definitively.

Symbol:



Title of the symbol: CSA symbol
Description: This product fulfills the requirements of the CAN/CSA-C22.2 No. 61010.

Symbol:**Title of the symbol:** Recycle symbol**Description:**

Indicates the item can be recycled where correct facilities exist.

1.3 Instrument type

All information provided in these Instructions for Use applies only to the instrument type indicated on the cover page. A nameplate indicating the instrument serial number is attached to the rear side of the instrument.

1.4 Intended purpose

The HistoCore PEGASUS Plus is an automated tissue processor specifically designed for fixation, dehydration, infiltration with intermedium and paraffin infiltration of human tissue specimens used for histological medical diagnosis by a pathologist, e.g. for cancer diagnosis.

The HistoCore PEGASUS Plus is designed for in vitro diagnostic applications.

**Warning**

- Any other use of the instrument is considered Off Label use. Failure to observe these instructions may result in an accident, personal injury, damage to the instrument, accessories, or specimens. Proper and intended use includes compliance with all inspection and maintenance instructions, along with the observance of all instructions in the Instructions for Use.

1.5 Qualification of personnel

- The HistoCore PEGASUS Plus must be operated by trained laboratory personnel only. The instrument is intended for professional use only.
- All laboratory personnel designated to operate this instrument must read these Instructions for Use carefully and must be familiar with all technical features of the instrument before attempting to operate it.

1.6 Statement for user data security and privacy

Leica Biosystems respects user data security and privacy. Our statement for user data security and privacy below will inform you that the below user data will be collected and used by instrument.

- Pictures of baskets with cassettes: Pictures of the baskets including all information on processed cassettes in baskets will be collected to track the run details of the cassettes and retained for 90 days.
- Use of usernames and user IDs: User account information including user name, password and badge info for authentication and authorization will be collected, retained till removal by Administrator. And the database used to store account information will be encrypted.

2. Safety

2.1 Safety notes

The Instructions for Use includes important information related to the operating safety and maintenance of the instrument.

The Instructions for Use is an important part of the product, and must be read carefully prior to startup and use, and must always be kept near the instrument.

This instrument has been built and tested in accordance with the safety requirements for electrical equipment for measurement, control, and laboratory use.

To maintain this condition and ensure safe operation, the user must observe all notes and warnings contained in the Instructions for Use.

The safety and caution notes in this chapter must be observed at all times.

Be sure to read these notes even if you are already familiar with the operation and use of other Leica Biosystems products.

The Instructions for Use must be appropriately supplemented as required by the existing regulations on accident prevention and environmental safety in the operator's country.



Warning

- The protective devices located on the instrument and the accessories must not be removed or modified. Only qualified service personnel authorized by Leica Biosystems may repair the instrument and access its internal components.
- If the instrument is to be returned to Leica Biosystems for repair, it must be cleaned and decontaminated in the appropriate manner (→ p. 186 – A1. [Decontamination Confirmation](#)).



Note

For current information about applicable standards, please refer to the CE Declaration of Conformity and UKCA Certificates on our Internet site:
<http://www.LeicaBiosystems.com>.

Electromagnetic compatibility, emitted interference, and immunity to interference are applicable, as are the requirements in accordance with IEC/EN 61326-2-6. The requirements in accordance with IEC/EN 61010-1, IEC/EN 61010-2-101, IEC/EN 61010-2-010, and ISO 14971 with regard to safety information are applicable.

This equipment has been designed and tested to CISPR 11 Class A. In a domestic environment it may cause radio interference, in which case, you may need to take measures to mitigate the interference.

The electromagnetic environment should be evaluated prior to the operation of the instrument.

Do not use this instrument in close proximity to sources of strong electromagnetic radiation (e.g. unshielded intentional RF sources), as these can interfere with the proper operation.

2.1.1 Dos and Don'ts

Setup/validation processes

- **DO** set up protocols with adequate number of dehydrating, clearing and paraffin steps.
- **DO** validate the carryover (check the actual concentration of the changed Ethanol/Xylene with hydrometer on a regular basis).
- **DO** set the thresholds to a realistic value for that laboratory. (For low throughput labs, consider multiple thresholds to optimize outcomes.)
- **DON'T** run the invalidated protocol for clinical use.

- **DO** enable 'Paraffin Clean' for IPA.
- **DON'T** enable 'Paraffin Clean' for Xylene substitute (e.g., Sub-X).

Operation

- **DO** check the reagent/paraffin level before running the protocol.
- **DO** correctly input the number of cassettes in each run.
- **DON'T** load more than 2 baskets or more than 200 cassettes in a single retort.

- **DO** perform a cleaning run after each processing run.
- **DON'T** clean embedding molds or metal cassette lids in the retort.
- **DON'T** leave tissue in retort during a clean cycle.
- **DON'T** reprocess tissue with the clean cycle.

Change reagent/wax

- **DO** screw the bottle cap on properly.
- **DO** select the correct action when replacing a reagent bottle.
- **DO** insert Paraffin vent plug into air vent when adding paraffin pellets/liquid paraffin.
- **DON'T** overfill reagent bottles and paraffin baths.

Cleaning and maintenance

- **DO** clean the liquid level sensors after each run.
- **DO** inspect and clean the retort filter daily.
- **DON'T** ignore the reminder to check and empty the condensate bottle.

2.2 Warnings

The safety devices installed in this instrument by the manufacturer only constitute the basis for accident prevention. Operating the instrument safely is, above all, the responsibility of the owner, as well as the designated personnel who operate, service, or repair the instrument.

To ensure trouble-free operation of the instrument, be sure to comply with the following instructions and warnings.

2.2.1 Markings on the instrument itself



Warning

Failure to follow the correct operating instructions (as defined in the Instructions for Use) of the corresponding markings and warning triangles on the instrument.

Serious injury of persons and/or damage to instrument, accessories, or specimen.

- Pay attention to the markings on the instrument and strictly follow operating instructions described in the Instructions for Use when operating or replacing the item marked.

2.2.2 Transport and installation



Warning

Accessories/components may become loose/damaged during transportation.

Sample damage

- The packaging has two indicators, ShockDot Impact Indicator and Tilt Indicator, that indicate improper transport. When the instrument is delivered, check this first. If one of the indicators is triggered, the package was not handled as prescribed. In this case, please mark the shipping documents accordingly and check the shipment for damage.



Warning

Accessories may fall or drop to users while unpacking.

People injury

- Follow the unpacking instructions carefully to avoid damage to the instrument.
- At least two persons are required when unpacking the instrument.
- Once unpacked, the instrument must be transported only in an upright position.



Warning

The instrument tilts while moving during the first installation.

People injury

- At least two persons are required to hold the instrument when it is rolled off the pallet via the ramp.



Warning

Lift the instrument without tools or equipment.

The instrument may fall or drop on users when being lifted, which causes people injury.

- Always use suitably rated lifting equipment, such as a trolley or forklift, when moving the instrument upstairs.



Warning

Move the instrument loaded with reagents and paraffin, and/or with power cord connected.

People injury.

- Prior to every transport in which it is possible for the instrument to be shaken, tilted, or lifted, the instrument must be cleaned including the tubing, paraffin baths, and reagent bottles. The power cord must be disconnected.

2 Safety



Warning

Accessories/components/devices may become loose or damaged during transportation.

Sample damage

- Paraffin oven covers must be closed during transportation.
- Retort lids must be locked during transportation.



Warning

Accessories/components may become loose/damaged during transportation

Sample damage

- Before switching the instrument on, visually check the instrument and accessories for any damages possibly caused during transportation or while moving the instrument.



Warning

Accessories/components may become loose/damaged during transportation

Sample damage

- Before processing patient tissue samples after transportation or moving the instrument, perform a test run to ensure the suitability of the instrument and the protocol used. Either use a pre-defined protocol or combine this activity with the validation of your own protocols.
- Only process patient tissue samples for diagnostic purposes, after all the above checks have been performed successfully. If any of the previous steps failed, do not operate the instrument and contact your local Leica Biosystems Service Representative.



Warning

Insufficient or no exhaust system/Wrong connection to the exhaust system

People injury due to leaked vapor or excessive fumes

- Never run the instrument without the active carbon filter or an external exhaust system, as this will release potentially dangerous fumes into the laboratory.
- It is recommended to use an external exhaust system.
- Even if the instrument is connected to an external exhaust device, the active carbon filter provided must remain in use.



Warning

The instrument is plugged into a power board with other instruments.

The instrument may work with unstable current/power, which leads to sample damage.

- Do not use an extension cable.
- Plug the instrument only into a grounded power socket. Make sure an obligatory use of a CB (Circuit breaker).



Warning

The drip tray is not installed or is installed incorrectly and liquid flows onto the floor.

People injury.

Environment contamination.

- Do not use the instrument without installing the drip tray.
- Wear PPE (Personal Protection Equipment) when using the instrument.

2.2.3 Operating the instrument



Warning

The connector does not match the tube/Connector corrosion; Reagent bottle overflow (the external reagent quantity does not match the reagent bottle, etc.); Bottle falling during reagent fill or exchange; The tube becomes loose during draining.

People slip or inhale toxic/dangerous fume.

Biohazard because of waste reagent.

Environment contamination.

- Always wear chemical protective clothing, protective goggles, respirator, rubber gloves, and all other necessary personal protective equipment, when handling the reagents. Reagents used for tissue processing can be both toxic and/or flammable.
- Always use the tube supplied with the instrument.
- Never fill a reagent station that has contents already in it.



Warning

Inappropriate carryover settings for the sample types being processed can cause sample damage!

To ensure correct carryover settings:

- For carryover settings, please refer to Chapter 6.1.5 'Carryover setting'.
- The pre-defined and customized protocols (carryover value included) must be validated by the laboratory according to their standard operating procedure.



Warning

The retort is not empty before remote fill.

Sample damage.

- Check the retort and make sure nothing is left in the retort before running a protocol.
- Ensure the reagent bottle is properly connected and the liquid level in reagent bottle is between the maximum and minimum indicator.



Warning

User fills in too much solid/melted paraffin into paraffin bath. This may cause the paraffin to enter into the air system or cross-contaminations of paraffins.

Sample damage/ Instrument blockage.

- Always use a vent plug when filling paraffin and pay attention not to exceed the maximum level mark.
- Before starting the protocol, check that the paraffin level is between the maximum and minimum marks.

2 Safety



Warning

Open/Close paraffin bath lid; Fill melted paraffin; The connector does not match tube / Connector corrosion; The tube becomes loose during draining; The waste paraffin container is not ready/not stable when draining starts via GUI; Pull out the drain tube.

Hands/fingers get scald.

People slip or inhale toxic/dangerous fume.

Biohazard because of the contaminated paraffin.

Environment contamination.

- Wear chemical protective clothing, protective goggles, respirator, rubber gloves, and all other necessary personal protective equipment when filling/draining melted paraffin. Used paraffin can be contaminated.
- Always use the hose supplied with the instrument.
- Ensure you use the correct size paraffin drain hose to avoid paraffin leakage.
- The paraffin leaving the tube will be hot and may cause burns. Make sure the paraffin drains to a suitable container and stand clear while it drains.
- Do not remove the remote fill/drain tube until the software indicates the process is complete and pressurized air has cleared the tube. A cessation of reagent flow is not an indication that the procedure is complete.



Warning

User defined protocols are not validated.

Sample damage

- The pre-defined protocols and the customized protocols have to be validated by the user before running the protocol, i.e. tissue processing with patient tissue for diagnostics, according to the local or regional accreditation requirements.



Warning

The RMS (Reagent Management System) is set to N/A or a wrong value.

The reagent consumption status can not be monitored, which may impact the tissue processing quality and cause sample damage.

- Do not set the RMS to N/A. Use RMS to monitor reagent consumption status.
- The RMS settings must be validated by the user before running the protocol, i.e. tissue processing with patient tissue for diagnostics, according to the local or regional accreditation requirements.

**Warning**

Open retort while the instrument is processing/after pausing/after the protocol ends, the user gets contact with the hot surface of lid/baskets/fluids/hazardous reagents/vapor from the retort.

Open the retort and the protocol cannot continue.

People injury/Sample damage/Impaired samples

- Hot surface. Wear chemical protective clothing, protective goggles, respirator, rubber gloves, and all other necessary personal protective equipment during operation.
- Do not open the retort lid or remove reagent bottles/paraffin oven cover/paraffin baths when a protocol is running, unless a system message indicates to do so. Whilst a protocol is running, if you want to remove the specimens from the retort or add specimens to the retort, press the pause button.
- Take care if opening a retort or paraffin bath after pausing the instrument. Read any warning messages—for example, the retort is above safe access temperature—and take appropriate precautions before continuing.
- Molten paraffin is hot and may cause burns. Be careful when handling paraffin and removing baskets.

**Warning**

Knock retort lids when they are open.

People injury. Fingers or hands are crushed.

- Do not knock retort lids when they are open.

**Warning**

Processing starts when paraffin is not completely melted.

Sample damage

- Make sure that the paraffin in the paraffin baths is completely melted before pressing the Start button.

**Warning**

Samples are not covered by reagents/paraffin.

Samples dried out and got damaged.

- Before running the protocol, check the reagent level in reagent bottles from the outside. Make sure that reagents level is between Min. and Max. marks. Check the paraffin levels as well.
- Do not add samples over the level sensor.
- Do not add specimens more than suggested.
- Always ensure the cassettes are correctly inserted into the baskets and that the baskets are correctly placed in the retorts.
- Station selection protocols are not recommended for overnight processing. If a reagent becomes unavailable for any reason, then the protocol cannot finish.

2 Safety



Warning

Incorrect setup of the concentrations

Sample damage or reduction in tissue processing quality

- Do not alter the concentration of a used reagent unless you are able to verify the actual concentration.



Warning

Wrongly set up reagent temperature threshold over its boiling point.

People injury/Sample damage/Environment contamination due to excessive fumes generated during processing.

- Take extreme care when deciding to change a reagent temperature threshold. Raised thresholds can lead to reagents boiling. Boiling reagents will release large quantities of fumes that may overload the internal active carbon filter or (if fitted) the external exhaust system. Boiling reagents are also likely to lead to excessive pressures within the instrument, increased reagent contamination and reagent spills. Reagent boiling points are lower when in a retort operating with a vacuum or with pressure/vacuum cycling.
- Never run the instrument without the active carbon filter or an external exhaust system. Even if the instrument is connected to an external exhaust device, the active carbon filter provided must remain in use.



Warning

Wrong definition of reagents

Sample damage caused by reagents mismatch between GUI definitions and bottle labels.

- Always update station details correctly.
- Always check the definition of stations at/before the protocols start.
- Never update the details without replacing the reagent.



Warning

Ignore the information provided by the instrument.

Update reagent/station parameters but not replace the reagent.

Do not update the reagent status on GUI from Empty to Full after filling the bottle.

Or set the status to Full before filling the bottle, but not filling the bottle or underfilling the bottle.

Sample damage caused by dirty or expired reagent, or insufficient reagent.

Delay of diagnosis.

- Always change reagents when prompted.
- Always update station details correctly.
- Never update the details without replacing the reagent.

**Warning**

Fill the reagent from an unstable container.

People injury - The fill/drain functions include a strong purge which may cause an unstable container to tip over and spill. The user may slip on the spilled reagent on the ground.

Environment contamination.

- Always ensure that you fill from or drain to a large stable container. The container must also be of sufficient volume to easily accommodate all of the drained fluid. If you use a small container you must support the container and tube during the fill or drain.
- Ensure you use the correct size paraffin drain tube to avoid paraffin leakage.
- Always wear chemical protective clothing, protective goggles, respirator, rubber gloves, and all other necessary personal protective equipment, when handling the reagents. Reagents used for tissue processing can be both toxic and/or flammable.

**Warning**

The instrument runs with missing reagent bottles or with loose or missing reagent bottle caps.

People slip or inhale toxic/dangerous fume.

Environment contamination.

- Never run the instrument with missing bottles or with loose or missing bottle caps.
- Never run the instrument without the carbon filter or an external exhaust system, as this will release potentially dangerous fumes into the laboratory.

**Warning**

The instrument runs with a missing condensate bottle or with a loose or missing condensate bottle cap.

People slip or inhale toxic/dangerous fume.

Biohazard due to the leak of toxic/dangerous fume.

- Never run the instrument without the condensate bottle or with the loose or missing condensate bottle cap.
- Never run the instrument without the carbon filter or an external exhaust system, as this will release potentially dangerous fumes into the laboratory.

**Warning**

Knock paraffin bath lids when they are open.

People injury

- Take care not to knock paraffin bath lids when they are open. They could crush fingers or hands.

**Warning**

Open a paraffin bath lid when there is paraffin in a retort or paraffin is being transferred.

People injury

- Never open a paraffin bath lid when there is paraffin in a retort or paraffin is being transferred. Hot paraffin may splash out of the bath.

2 Safety



Warning

Blockage by losing cassettes/tissues from retort or impurities from reagents or paraffin

Sample damage

- Use baskets during processing. Do not put the specimens into the retort directly.
- Check that the retort filter is installed at the retort bottom before running a protocol.
- Take care not to drop anything into the retort when the retort filter is removed. Foreign material in the pipes could stop valves from operating properly.



Warning

The local alarm/remote alarm is not connected.

Sample damage

- The remote alarm system/local alarm system shall be connected to the instrument.



Warning

Tissues are left in the retort when running the cleaning protocol.

Sample damage

- Remove all tissues from the retort before running a cleaning protocol as the dry step will damage the tissue.



Warning

Use cleaning protocol for sample reprocessing.

Sample damage

- Do not use cleaning protocols for reprocessing as the dry step will damage the tissue.



Warning

Use wrong/insufficient cleaning tools / reagents

Sample damage

- Do not reuse contaminated dehydrants as cleaning ethanol. The contaminated dehydrants will contain formalin (or other fixatives) and the dry step will cause salts to crystallize on the retort's internal surfaces.
- Always run a cleaning protocol after paraffin has been in the retort.



Warning

Unprocessed samples (with formalin residue) are placed into a retort prior to running a cleaning protocol.

Impaired samples - Formalin in the residue purged to the paraffin bath at the start of the cleaning run may damage tissue on subsequent runs.

- Do not load unprocessed tissue samples into a retort prior to running a cleaning protocol.
- If you inadvertently load unprocessed samples into a retort prior to running a cleaning protocol, remove the samples and attempt to load a processing protocol before loading the cleaning protocol. The purge before the cleaning run will be skipped.

**Warning**

Run cleaning protocol to clean additional materials other than baskets.

Impaired samples - Cleaning reagents degenerate at a faster rate. If the cycle purity threshold is not lowered, the low purity cleaning reagents leads to low-quality cleaning.

- Do not clean other materials using cleaning protocol.

**Warning**

Add fixed samples to a running protocol.

Impaired samples.

- Take care when adding fixed samples to a running protocol. The additional fixative will contaminate the reagent used in the current step and this contamination will not be tracked by the reagent management system.

**Warning**

Add more samples during processing.

Impaired samples.

- The further a protocol has progressed before you add more samples, the more compromised is the processing quality for those samples. You only add samples during fixative steps or during the first dehydrant step.

**Warning**

Pull out the mains cable or shut down the system while a protocol is running.

Sample damage due to the power failure

- Do not pull out the mains cable whilst the instrument is operating unless there is an emergency situation and both the front panel power button and the mains wall switch are inaccessible.
- Do not shut down the system while a protocol is running.

**Warning**

Use improper equipment during maintenance.

People injury – Users are hurt by hot surface/ sharp edge/ residues etc.

- Wear PPE during maintenance.

**Caution**

- In exceptional situations (e.g. accidental reagent spills), it may be necessary to wear a respirator. This depends on the specific local ambient temperature, room volume, additional load, ventilation rate etc. In case of doubt, the laboratory owner/operator must carry out a local measurement to prove that applicable maximum workplace concentrations are not exceeded. Measurements performed of maximum workplace concentrations that occur at an air change rate of 8.75 times per hour and a room temperature of 40 °C, room volume of 24 m³ and reagent temperature of 45 °C have shown that limit values are exceeded for short periods during the step when specimens are loaded in formalin. At lower ambient temperatures and/or larger room volumes in the laboratory or higher ventilation rates, the workplace concentration will be less. The exact concentration values can only be measured locally. The limits were complied with in all operating states.

2 Safety

2.2.4 Handling reagents



Warning

Using reagents other than the recommended reagents

People injury - Fire or explosion may be caused by some toxic/flammable reagents.

Delayed diagnosis - Components of the instrument may be damaged by corrosive reagents.

- Use reagents suggested below with the instrument only.
- Do not use fixatives containing picric acid as picric acid is explosive when dry.
- Do not use reagents containing corrosive chemicals such as mercuric salts, picric acid, nitric acid and hydrochloric acid.
- Do not use acetone or other ketones. These damage the instrument's valves.



Warning

Fail to fill reagent above minimum indicator, reagent bottles are under-filled, and tissue dries out during protocol.

Fail to fill reagent below maximum indicator, reagent bottles are overfilled, and excessive reagent cause cross-contamination.

Sample damage

- Check that the liquid level of each reagent bottle is between maximum and minimum indicators before starting the protocol or reagents filling.
- In case of under-filling, exchange the whole bottle of reagents or top up the reagent with the same concentration. In case of over-filling, pour out the excessive reagent of the reagent bottle.



Note

- Material safety data sheets can be obtained from the supplier of the chemicals. If using Leica branded reagents, MSDS are available online at <http://www.LeicaBiosystems.com>

2.3 Safety features on the instrument

The tissue processor is equipped with numerous safety functions and with sophisticated software control mechanisms. These ensure that the specimens remain undamaged in the event of a power failure or other malfunction during the infiltration process and that the infiltration is completed successfully.

Overpressure protection

- When power is switched off the pressure air pump and valves default to a safe condition (retort vented, no pressure generation).
- If the pump is not stopped at the correct moment during the pressurization, the power supply is interrupted by a separate electronic circuit.

Overcurrent protection

- The AC overcurrent conditions are protected against by the heating current detection mechanism.
- The DC overcurrent conditions are protected against by the separated heating power fuses.

Overheating protection

The heat limiters and software overheat error handling mechanism protect the instrument against the abnormally high temperature.

Over vacuum protection

The vacuum system is not capable of generating a dangerous vacuum condition.

3 Instrument Components and Specifications

3. Instrument Components and Specifications

3.1 Overview

3.1.1 Instrument components

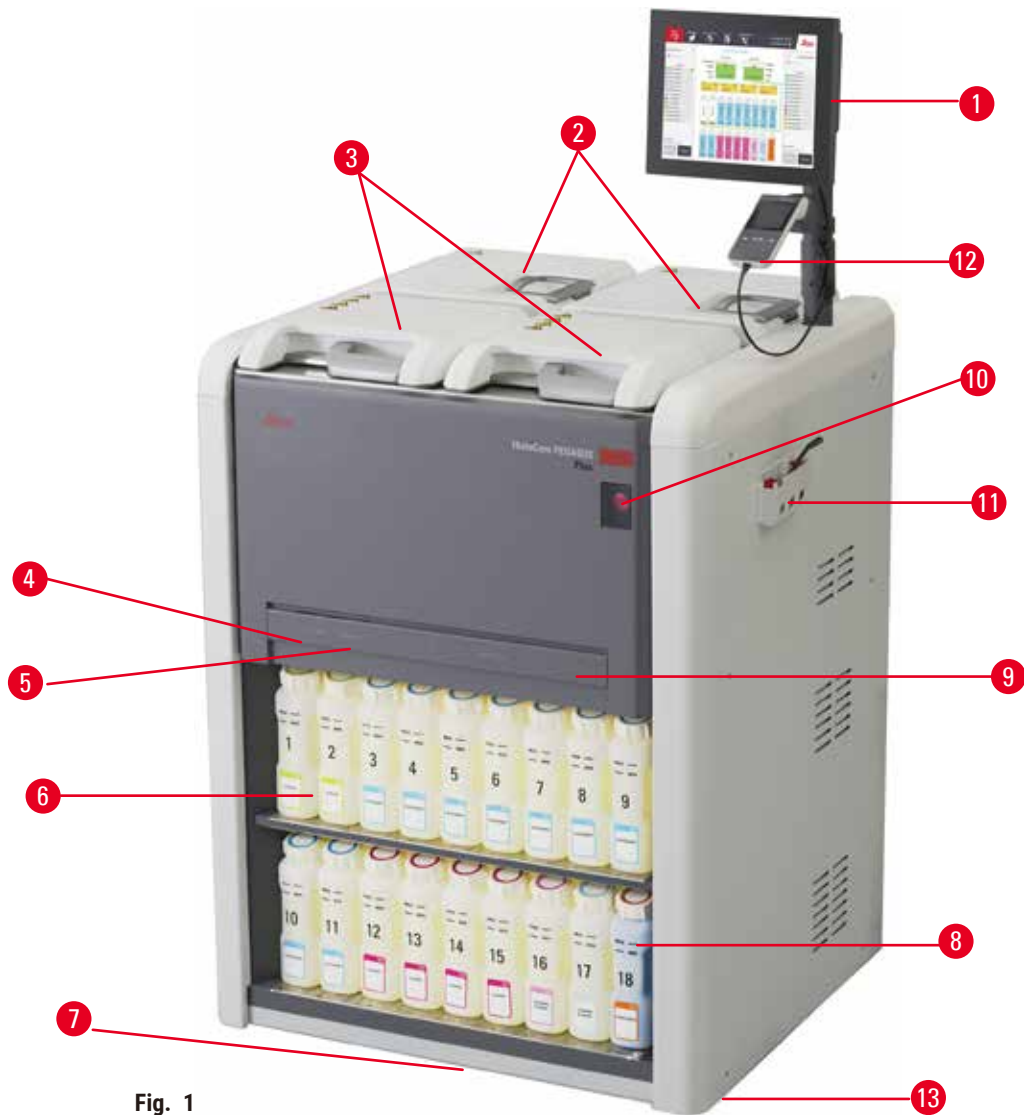

Fig. 1

- | | |
|--|--|
| 1. Display | 7. Drip tray |
| 2. Four paraffin baths | 8. Condensate bottle |
| 3. Two retorts | 9. Active carbon filter (behind the cover) |
| 4. Remote fill/drain port (reagent) (behind the cover) | 10. Mains power switch |
| 5. Remote drain port (paraffin) (behind the cover) | 11. Tool box |
| 6. Reagent bottles | 12. HistoCore I-Scan |
| | 13. Castors (not shown in this figure) |

3.1.2 Rear panel

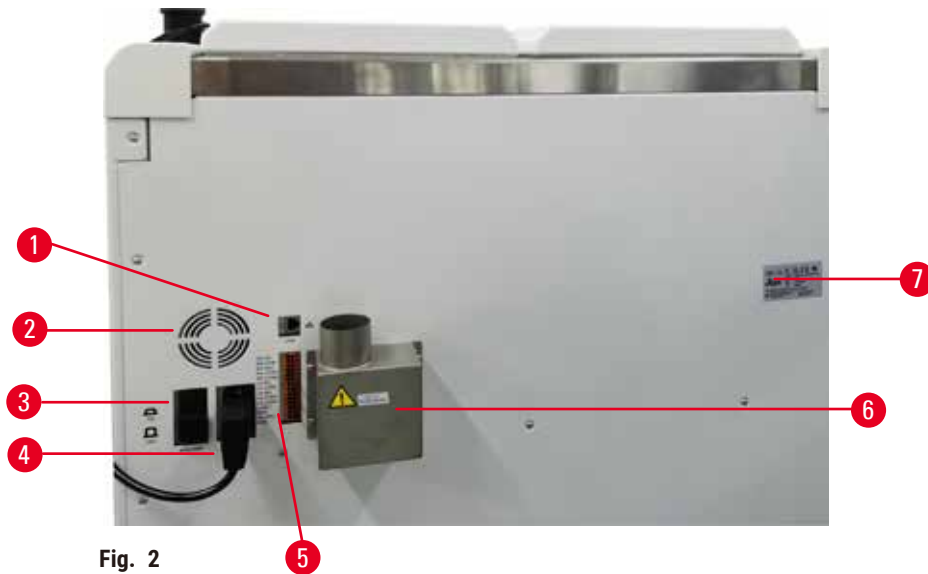

Fig. 2

- | | |
|----------------------|--|
| 1. Ethernet port | 5. Alarms and UPS connections |
| 2. Fan | 6. Exhaust interface (connect to an external exhaust device) |
| 3. Circuit breaker | 7. Nameplate |
| 4. Mains power inlet | |

3.2 Main features of the instrument

The HistoCore PEGASUS Plus (hereafter PEGASUS Plus) is a dual-retort tissue processor that offers fast, high-quality tissue processing for histology laboratories. With reagent capacity sufficient to run the two retorts independently, it allows a high degree of scheduling flexibility. Intelligent software lets you configure the instrument to suit your laboratory's workflows while providing checks and restrictions that help you avoid mistakes that could damage tissue.

Track and Trace capture 100% Of Your Cassettes:

Capture and record critical data with built-in track & trace features. The integrated iScan technology tracks basket ID, user ID, and reagent information. An optical scanner captures cassette ID, quantity, and color, enabling you to trace each sample in the tissue processing workflow.

Easy access to the recorded data gives you control over your tissue processing reports while minimizing manual documentation, maximizing confidence.

A precise reagent management system ensures low reagent consumption and reduces the reagent exchange workload.

3 Instrument Components and Specifications

The built-in density meter further limits the risk of lab errors during reagent change. It monitors such changes and alert users if there's an incorrect concentration to protect the integrity of the tissue.

Depending on your setup, the PEGASUS Plus uses this information to select the optimal reagent for each protocol step. It alerts you when to replace reagent, so that quality is never compromised, while at the same time ensuring you get full use of all reagents.

The clear, intuitive, touch-screen interface makes loading runs and monitoring them easy. Protocol configuration, reagent setup, and other system settings are equally straightforward.

HistoCore I-Scan, can capture and record all the data (cassette ID, color, barcode, size, quantity) you need to see with the unique image-based track and trace technology. Get full sample control to monitor tissue processing with less need for manual documentation, maximizing diagnostic confidence.

Pre-defined validated protocols give you the flexibility to process different tissue types with consistent quality.

The HistoCore PEGASUS Plus tissue processor supports xylene-free processing with isopropanol (IPA), Leica Sub-X, or Clearene.

During the xylene-free mode, paraffin life is extended with the feature Paraffin Purify.

Backlighting allows you to check the reagent level easily. Once the reagent expired, the certain reagent bottle with flash will give you a visual reminder. And the backlight will turn off once the reagent bottle is not connected correctly.

The magnetic stirrer technology is designed to optimize paraffin infiltration performance, helping to reduce processing time and enhancing reagent exchange within the tissue cells.

Reagent bottles with Anti-spillage design avoid reagent spill during reagent transfer.

Speed up the paraffin melting time to 3.5 hours with HistoCore PEGASUS Plus Parablocks, which perfectly matches the paraffin chamber paraffin fill volumes without topping off, and the elimination of pellet spills. If use Leica pellets, the melting time is about 4.5 hours.

The heated retort lid helps to quickly evaporate reagent residues on the retort lid to improve fume control.

Filling and draining reagents and paraffin can be done with the remote fill/drain function which minimizes exposure to reagents and hot paraffin.

3.3 Technical data

Electrical specifications

Nominal supply voltage	100-120VAC/220-240VAC
Nominal supply frequencies	50/60Hz
Power consumption	100-120VAC 15A Max.; 220-240VAC 10A Max.
Main input fuses	16A 250VAC

Dimensions and weight specification

Overall size of device in operating mode (Width x Depth x Height, mm)	804 x 715 x 1533
Overall size serial packaging (Width x Depth x Height, mm)	1040 x 1045 x 1480
Empty weight (without accessories, kg)	235kg
Overall weight (with accessories, kg)	315kg
Device weight including packaging (kg)	300kg

Environmental specification

Operating altitude (meters above sea level) (min/max)	Up to a max. of 2250 m above sea level
Temperature (operation) (min/max)	+10°C to +35°C
Relative humidity (operation) (min/max)	Humidity 20% to 80% non-condensing
Temperature (transit) (min/max)	-29°C to +50°C
Temperature (storage) (min/max)	+5°C to +50°C
Relative humidity (transit)	Humidity 10% to 85%
Relative humidity (storage)	Humidity 10% to 85% non-condensing
Minimum distance to walls (mm)	80 mm
BTU (J/s)	<ul style="list-style-type: none"> • 100-120V: maximum 6141.86 BTU/h (1800 J/s) • 220-240V: maximum 8189.14 BTU/h (2400 J/s)

Emissions and boundary conditions

Overvoltage category to IEC 61010-1	Overvoltage installation category II
Pollution degree to IEC 61010-1	Pollution degree 2
Means of protection to IEC 61010-1	Class I
Degree of protection to IEC 60529	IP20
A-weighted noise level, measured at 1 m distance	<70dB(A)
EMC class	Class A

Tissue processor

Local/remote alarm relay	30V DC, maximum 1A
Number of reagent containers	17 reagent bottles, 1 condensate bottle
Maximum bottle volume	Max. 3.88 L

Paraffin containers

Number of paraffin baths	4
Capacity	Max. 3.9L per paraffin bath
Melting time	Max. 7 hours an ambient temperature of 23°C to 25°C (set the paraffin type as "Recommended")
Temperature settings range	<ul style="list-style-type: none"> • Paraffin melting point setting: 50°C to 65°C • Standby temperature setting: Paraffin Melting Point +2°C and max. 71°C

Retort	
Capacity	Max. 2 x 200 cassettes
Temperature (paraffin)	Paraffin temperature selectable from 58°C to 85°C.
Temperature (processing reagents)	Ambient temperature or 35°C to 65°C
Temperature (cleaning reagents)	35°C to 85°C
Filling vacuum	-60 kPa
Draining pressure	45 kPa
Other specifications	
CE	Approved
CSA	Approved
Reagent Management System (RMS)	<ul style="list-style-type: none"> • Processing protocol: Cassettes/Cycles/Days/Concentration • Cleaning protocol: Cycles/Days
Drip Tray	<ul style="list-style-type: none"> • >3.88L
Access levels	<ul style="list-style-type: none"> • Operator • Supervisor • Administrator • Service • Manufacturer
Password status	<ul style="list-style-type: none"> • Operator • Supervisor • Administrator • Service • Manufacturer
Type of password	A password must contain minimum 6 characters, at least one letter and one number.
Hardware and Software	<ul style="list-style-type: none"> • Color LCD touchscreen • User-friendly, intelligent software • Three USB 2.0 ports, DC 5V • Alarm system with two alarm sockets (for local alarm and remote alarm). • Smart error handling for specimen protection.
Capacities	<ul style="list-style-type: none"> • 20 freely configurable protocols. 4 pre-defined protocols. Xylene pre-defined protocols consist of up to 10 reagents and 3 paraffin processing steps. Xylene-free pre-defined protocols consist of up to 8 reagents and 3 paraffin processing steps. --Time per protocol step: 0 - 5999 minutes. --Delay time: max. 1000 hours. • Up to 400 cassettes can be processed simultaneously. • 1 pre-defined cleaning protocol for the retort.

4. Setting up the Instrument

4.1 Installation site requirements

- It is the user's responsibility to make sure that a compatible electromagnetic environment is maintained so that the instrument can work as intended.
- The installation location must be protected against electrostatic discharge.
- The chemicals used in the instrument are easily inflammable and hazardous to health. Therefore, the installation location must be well ventilated, and must contain no open flames. The room in which the instrument is located must not be used as a permanent station for people. Otherwise, the room must be equipped with an exhaust device.
- Do not operate the instrument in rooms with explosion hazard.
- Avoid vibrations, direct sunlight, and heavy variation in temperature.
- The instrument requires an installation area of approx. 900mm x 800 mm.
- The substrate must have a sufficient load capacity and rigidity with respect to the weight of the instrument.
- The instrument is designed for indoor use only.
- To ensure proper functioning of the instrument, it must be set up while maintaining a minimum distance of 80 mm from walls and furniture.
- The instrument must be installed in a place that ensures an easy disconnection from the power supply. The power cable must be in a place that can be easily reached.
- No extension cable can be connected.
- The instrument must be connected to a grounded power socket.
- Use only the provided power cords intended for the local power supply.

4.2 Standard delivery - packing list

Quantity	Part description	Order No.
1	HistoCore PEGASUS Plus basic instrument	14 0488 58008
1	HistoCore I-Scan kits	14 0488 60946
1	Basket hook	14 0488 58177
4	Cassette basket	14 0488 58160
4	Blue clip sets with datamatrix	14 0488 58176
4	Black clip sets with datamatrix	14 0488 58173
10	Printed barcode stickers	14 0488 60133
1	Reagent bottle assembly	14 0488 57899
2	Bottle cap assembly	14 0488 78231
2	Paraffin bath vent plug	14 0488 58088

Quantity	Part description	Order No.
1	Exhaust Interface	14 0493 53387
1	Active carbon filter	14 0488 58136
1	Remote fill/drain tube for reagents	14 0488 60134
1	Remote drain tube for paraffin	14 0488 60135
1	Paraffin scraper	14 0393 53643
1	Molykote 111 grease, 100g	14 0336 35460
20	O-Ring	14 0493 51361
2	Sets of adhesive labels for bottles	14 048860131
1	Set of adhesive number labels for bottle	14 0488 60148
1	Accessory pocket assy	14 0488 60153
1	Cross-connector 21.85*5 mm	14 6000 05407
1	Drip tray	14 0488 59324
1	Level sensor brush	14 0488 58099
2	Bumper	14 0488 59321
4	M4x8 EN ISO 7380	14 3000 00065
2	M6x35 ISO4762 fully thread	14 3000 00537
1	Straight Screwdriver	14 0488 60138
1	Allen key size 2.5	14 0488 60139
1	Allen key size 3.0	14 0488 60140
1	Allen key size 4.0	14 0488 60141
1	Allen key size 5.0	14 0488 60137
2	Ratchet spanner 17mm	14 0488 60142
1	Instructions for Use (printed in English with additional languages on data carrier 14 0488 80200)	14 0488 80001

If the supplied local power cord is defective or lost, please contact your local Leica representative.



Note

- Please check all delivered parts against the packing list and against your order to verify whether the delivery is complete. Should you find any discrepancies, please contact your Leica Biosystems sales office without delay.

4.3 Unpacking and installation

4.3.1 Unpacking Instructions



Warning

Accessories/components may become loose/damaged during transportation

Sample damage

- The packaging has two indicators, ShockDot Impact Indicator (→ Fig. 3-1) and Tilt Indicator (→ Fig. 3-2), that indicate improper transport. When the instrument is delivered, check this first. If one of the indicators is triggered, the package was not handled as prescribed. In this case, please mark the shipping documents accordingly and check the shipment for damage.



Warning

Accessories may fall or drop to users while unpacking.

People injury

- Follow the unpacking instructions carefully to avoid damage to the instrument.
- At least two persons are required when unpacking the instrument.
- Once unpacked, the instrument must be transported only in an upright position.



Fig. 3

Sufficient surface area is required for unpacking the instrument. The distance to the nearest wall must be at least 1 m on the side and rear. On the front, the distance must be at least 3 m, as the instrument is rolled from the pallet in this direction. The room height must be at least 3.2 m, as the packaging must be removed by pulling it upwards.

1. Bring the instrument packaging (→ Fig. 3-3) as close as possible to the final installation location. Remove the straps (→ Fig. 3-4).

4 Setting up the Instrument

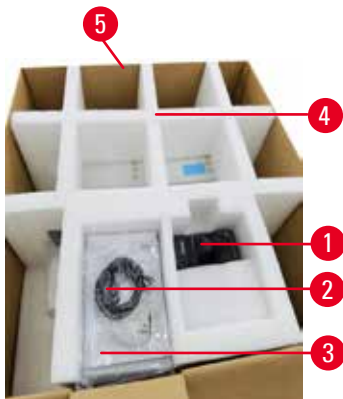

Fig. 4

2. Open the packaging and remove the display (→ Fig. 4-1), power cord (→ Fig. 4-2), and the Instructions for Use (→ Fig. 4-3) from the transport anchor (→ Fig. 4-4).
3. Take the transport anchor made of foam out.
4. Remove the outer sleeve of the packaging (→ Fig. 4-5) from the pallet by pulling it upwards.



Fig. 5

5. The small packaging box (→ Fig. 5-1) contains the accessories that are not yet installed in the instrument. Carefully set the small packaging box aside.
6. Carefully remove the plastic dust cover from the instrument.



Fig. 6

7. Remove screws (→ Fig. 6-1) that anchor the instrument on the pallet. Firstly, remove 4 screws at 4 corners. To do so, loosen the screws at cross corners in turns by two persons using spanners. Then, loosen the screws at front and rear sides.
8. Pull out the two rails (→ Fig. 6-2) for the ramp beneath the instrument by pulling them forwards.
9. Hook these rails on the left and right with the panel into the groove of the pallet so that they are flush with the wooden board that holds the instrument.
10. Now release the brake lever on the two front transport castors so that the instrument can be moved.

**Warning**

The instrument tilts while moving during the first installation.

People injury

- At least two persons are required to hold the instrument when it is rolled off the pallet via the ramp.



Fig. 7

11. When rolling the instrument down from the pallet, support it by the outer top corners using both hands.
12. After the instrument has been rolled off the pallet, it can be brought to its final location.
13. When the instrument is set up in its final location, the brakes on the instrument castors must be engaged once again. To do so, push the lever back downwards.

**Note**

- The transport carton and included retaining elements should be kept in case a return shipment is necessary later. To return the instrument, follow the instructions above in reverse order.

4 Setting up the Instrument

4.3.2 Installing the display

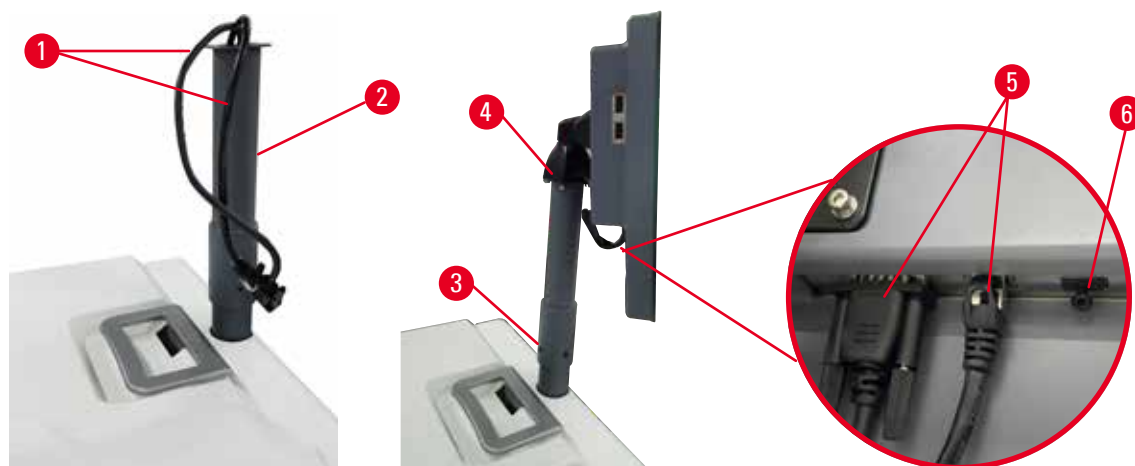

Fig. 8

1. Guide two cables (→ Fig. 8-1) through the display support bracket (→ Fig. 8-2).
2. Fix the display support bracket by fastening 4 screws (→ Fig. 8-3) at its lower end.
3. Install the display by fastening 4 screws (→ Fig. 8-4) at the top end of the display support bracket.
4. Plug in two cables (→ Fig. 8-5). The cables are not applicable for hotplug.
5. Remove the plastic plug (→ Fig. 8-6) from the USB port and plug in the scanner cable.

4.3.3 Active carbon filter



Warning

Insufficient or no exhaust system/Wrong connection to the exhaust system

People injury due to leaked vapor or excessive fumes

- Never run the instrument without the active carbon filter or an external exhaust system, as this will release potentially dangerous fumes into the laboratory.
- It is recommended to use an external exhaust system.
- Even if the instrument is connected to an external exhaust device, the active carbon filter provided must remain in use.

The active carbon filter absorbs reagent fumes, thus preventing them from entering the laboratory atmosphere. To ensure that the active carbon filter operates effectively, it must be replaced periodically. Supervisors can set a replacement threshold by tapping **Carbon filter threshold** on the **Settings > Instrument settings** screen.

To insert/replace the active carbon filter, open the remote fill/drain cover (→ Fig. 9-1). Then push the active carbon filter (→ Fig. 9-2) in as far as it will go. The date on which the active carbon filter has been inserted can be marked on the label on the front side.



Fig. 9

4.3.4 External exhaust system



Warning

Insufficient or no exhaust system/Wrong connection to the exhaust system

People injury due to leaked vapor or excessive fumes

- Never run the instrument without the active carbon filter or an external exhaust system, as this will release potentially dangerous fumes into the laboratory.
- It is recommended to use an external exhaust system.
- Even if the instrument is connected to an external exhaust device, the active carbon filter provided must remain in use.

The instrument has been designed so that it can be connected to an external exhaust device. The optional delivery includes the extraction tube for this purpose. It is recommended to use an external exhaust system.



Fig. 10

Attach one end of the extraction tube to the upwards-pointing tube (→ Fig. 10-1) of the exhaust interface and push it down as far as it will go. Connect the other end of the extraction tube with the external exhaust station.

4.4 Basic instrument/hardware

4.4.1 Retorts



Fig. 11

There are two retorts, each holding up to 200 cassettes in two cassette baskets. Each retort operates independently, with its own temperature, pressure, and stirrer On/Off settings. The system schedules resources so that both retorts can operate efficiently. The scheduling ensures that simultaneously running protocols do not use the same reagent bottle at the same time.

Two retort lids are heated during running protocols, minimizing hazardous fumes breathed by users when the retort lids are open after a protocol is paused, aborted, or completed.

Opening and closing retort Lids

Use the handles in the front of the instrument to lock/unlock a retort lid.

To open the retort, turn the handle clockwise (→ Fig. 11-1) and open the retort lid by lifting the front end of the retort lid (→ Fig. 11-2). Do not try to pry the handle. To lock the retort, push the handle back to the place with strength.

Always be aware of the contents, temperature and pressure of a retort before opening it. In some cases you may need to set the retort pressure and temperature manually before you can safely open it.

You may see a warning if the retort temperature is greater than either the retort empty access temperature (shown on the [Settings > Processing settings](#) screen) or the safe access temperature associated with the reagent in the retort (set on the [Reagents > Reagent types > Temperature thresholds](#) screen).

In urgent cases when the retort lid is locked by magnetic malfunction and cannot be lifted, pry up the black cover (→ Fig. 12-1) beside the retort handle, insert a straight screwdriver in the hole, and keep it in the position. This releases the e-lock. The retort lid can be opened. Then remove the straight screwdriver and insert the black cover back to the place.

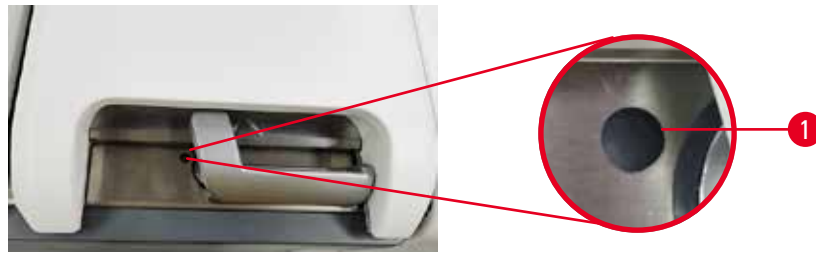

Fig. 12

**Warning**

Open retort while the instrument is processing/after pausing/after the protocol ends, the user gets contact with the hot surface of lid/baskets/fluids/hazardous reagents/vapor from the retort.

Open the retort and the protocol cannot continue.

People injury/Sample damage/Impaired samples

- Hot surface. Wear chemical protective clothing, protective goggles, respirator, rubber gloves, and all other necessary personal protective equipment during operation.
- Do not open the retort lid or remove reagent bottles/paraffin oven cover/paraffin baths when a protocol is running, unless a system message indicates to do so. Whilst a protocol is running, if you want to remove the specimens from the retort or add specimens to the retort, press the pause button.
- Take care if opening a retort or paraffin bath after pausing the instrument. Read any warning messages—for example, the retort is above safe access temperature—and take appropriate precautions before continuing.
- Molten paraffin is hot and may cause burns. Be careful when handling paraffin and removing baskets.

**Warning**

Knock retort lids when they are open.

People injury. Fingers or hands are crushed.

- Do not knock retort lids when they are open.

Venting a retort

You must ensure that there is no pressure or vacuum inside a retort before you open the retort lid. The retorts automatically vent at the start and end of a protocol, and also during a pause in a protocol. However, you may need to manually vent a retort if an automatic vent fails or if you wish to access a pressurized or evacuated retort at other times.

Use the **Reagents > Manual operations** screen to manually vent the retorts. Select the retort you want to open, and tap **Vent** button for that retort. You may need to wait up to 90 seconds for the pressure to equalize.

4 Setting up the Instrument



Note

- If you leave a hot retort closed for an extended time, the air in the retort will cool and create a vacuum. You must then vent the retort before opening the retort lid.

Fill levels



Fig. 13

Retorts can be filled with enough reagent for two cassette baskets. Markings on the reagent bottles (→ Fig. 13-1) and in the paraffin baths (→ Fig. 13-2) will help you determine if you have enough reagent to fill the retorts to the required level. Always keep the reagent and paraffin volumes well above the minimum (**MIN**) level, but below the maximum (**MAX**) level. Reagent/paraffin levels below the minimum will cause protocols to either fail or use a sub-optimal reagent sequence. Reagent/paraffin levels higher than the Maximum will cause reagent contamination, protocol abortion, or tissue damage.



Warning

Fail to fill reagent above minimum indicator, reagent bottles are under-filled, and tissue dries out during protocol.

Fail to fill reagent below maximum indicator, reagent bottles are overfilled, and excessive reagent cause cross-contamination.

Sample damage

- Check that the liquid level of each reagent bottle is between maximum and minimum indicators before starting the protocol or reagents filling.
- In case of under-filling, exchange the whole bottle of reagents or top up the reagent with the same concentration. In case of over-filling, pour out the excessive reagent of the reagent bottle.



Warning

User fills in too much solid/melted paraffin into paraffin bath. This may cause the paraffin to enter into the air system or cross-contaminations of paraffins.

Sample damage/ Instrument blockage.

- Always use a vent plug when filling paraffin and pay attention not to exceed the maximum level mark.
- Before starting the protocol, check that the paraffin level is between the maximum and minimum marks.

Liquid level sensors

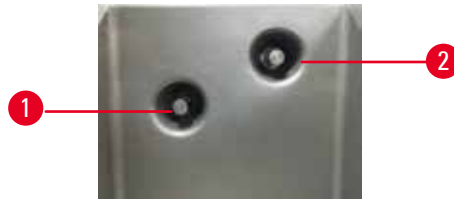

Fig. 14

Each retort has two liquid level sensors to monitor fluid levels. The lower sensor (→ Fig. 14-1) monitors the two-basket level. The top sensor (→ Fig. 14-2) is triggered if more than the maximum volume of fluid enters the retort. It serves a safety function.

The sensors may occasionally be affected by a build-up of condensation or deposited material. Always ensure the sensors are kept clean as part of regular retort cleaning (→ p. 152 – 9.3.1 Daily Tasks).

Magnetic stirrer

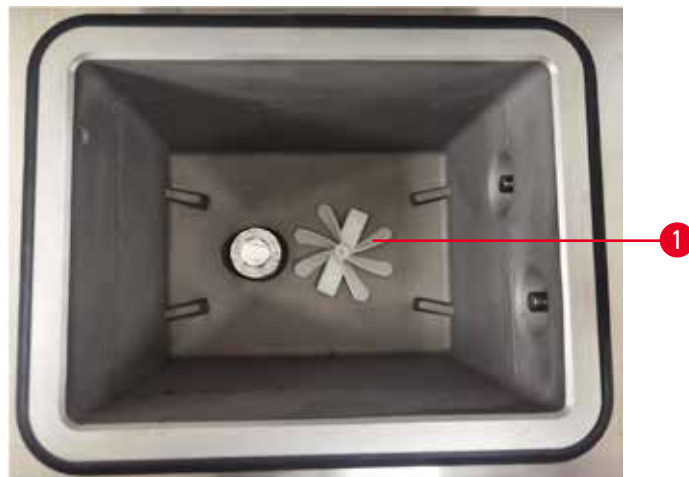

Fig. 15

Each retort has a magnetic stirrer (→ Fig. 15-1) that stirs the reagent or paraffin to ensure a consistent temperature and good tissue penetration. The stirrer is driven by a magnetically-coupled external motor. The stirrer can be turned on or off for each protocol step and is easily removed for cleaning (→ p. 152 – 9.3.1 Daily Tasks).

Retort filter

Each retort has a filter at the bottom. Install the filter by inserting and rotating it clockwise. Check and clean it regularly (→ p. 152 – 9.3.1 Daily Tasks).

4.4.2 Cassette baskets

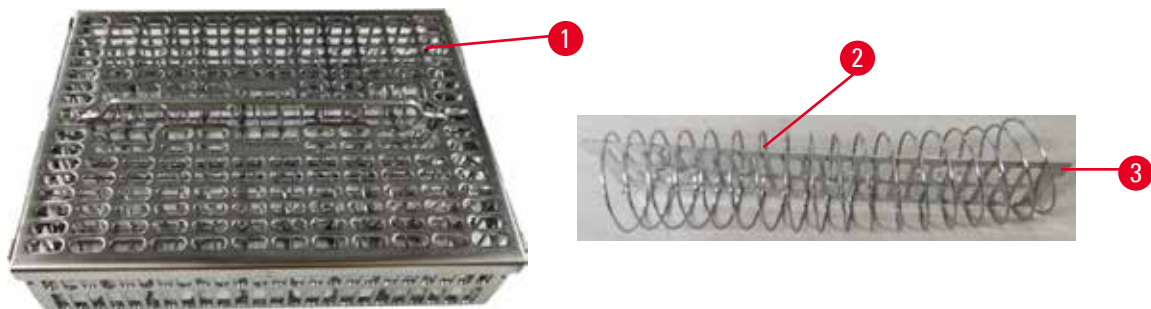

Fig. 16

The stainless-steel cassette baskets (→ Fig. 16-1) accept most common cassette types. Use the basket during processing. Do not put the specimens into the retort directly.

The spring of the basket (→ Fig. 16-2) is used to align the cassettes in the basket accurately and with the basket division board (→ Fig. 16-3) for inserting it into the basket.

With the spring, the basket can be filled with up to 72 specimen cassettes. Without a spring, the cassettes can be packed in more tightly, so that a maximum of 100 cassettes can fit in the basket.

The basket with spring ensures optimum reagent flow with minimal carryover and must be used for all xylene-free protocols.

Basket cover, basket handle, and basket hook

The basket cover fits firmly over the cage of the basket, with two lugs on the inside edges fitting into holes on the top sides of the cage. You can lift off the basket cover by firmly grabbing its sides and lifting upwards.

The basket handle is recessed along the central axis of the basket and can be extended by lifting it upward. The basket handle drops into the center recess with a small part left above the basket cover. It works as a stopper to the basket stacked above, so as to avoid dropping of the top basket during transferring.

A basket hook is supplied with the instrument. Use the hook to lift the basket from the retort.

Basket clips

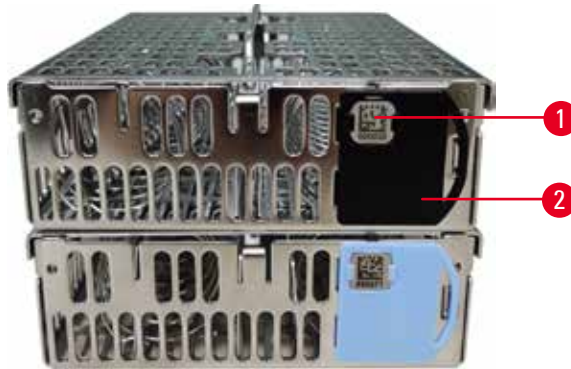

Fig. 17

Basket clips (→ Fig. 17-2) can be used for recommended protocols, that is, linking specific baskets with specific protocols. There are two colors of the clips, blue and black.

One pair of clips are provided with each basket. One clip of the pair has a unique barcode (→ Fig. 17-1) printed on it. This can be scanned before the basket is placed in the retort. The identified barcode is recorded along with the other details of the processing run (→ p. 146 – 8.3.4 Tracking options). After scanning the barcode and taking the basket image, you can place the basket in the retort.

It is recommended to use Leica Biosystems pre-defined/validated consumables (baskets and cassettes).

4.4.3 Paraffin baths

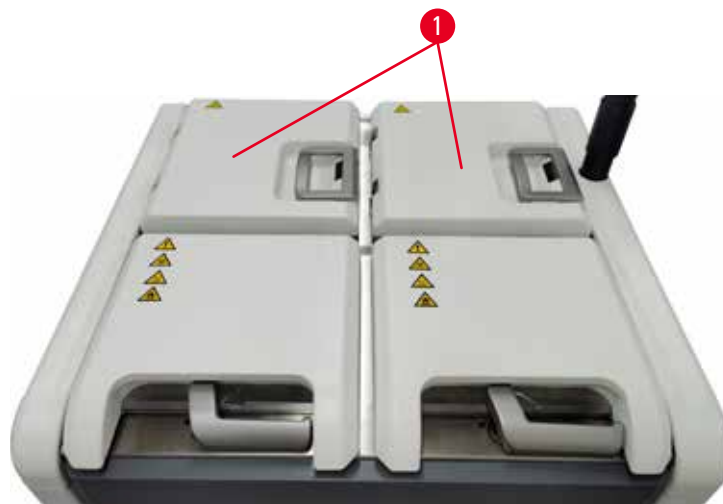

Fig. 18

Four paraffin baths are located at the top rear of the instrument accessed by two paraffin bath lids (→ Fig. 18-1). Each bath acts independently, holding enough paraffin to fill a retort. Although paraffin does not move between the paraffin baths, they are connected for air flow and so always have the same pressure.

Use the paraffin bath lid handles to open the paraffin bath lids. Be careful when opening the paraffin bath lids. If needed, rotate the display to give easy access to the paraffin bath (→ Fig. 23). Always use the paraffin bath handles to close the lids, ensuring the lids are properly latched.

Always ensure that the paraffin bath pressure is at ambient pressure before opening the paraffin bath lid. If the pressure is not ambient, vent the paraffin bath first. You can do this when you pause a running protocol or when the instrument is idle. Access the **Vent** button from the **Reagents > Manual operations** screen (→ p. 131 – 8.1.1 Manual operations).

View the current temperature of each paraffin station by going to **Reagents > Stations > Paraffin chambers**.

Depending on the paraffin you use, you can set the instrument to clean the paraffin in the paraffin bath (→ p. 141 – 8.3.2 Processing settings).

Drain used paraffin with commands on the **Reagents > Remote fill/drain** screen. Directly fill the paraffin baths with molten or solid paraffin with vent plug (→ p. 128 – 7.4.5 Replacing paraffin).

**Warning**

Open a paraffin bath lid when there is paraffin in a retort or paraffin is being transferred.

People injury

- Never open a paraffin bath lid when there is paraffin in a retort or paraffin is being transferred. Hot paraffin may splash out of the bath.

**Warning**

Knock paraffin bath lids when they are open.

People injury

- Take care not to knock paraffin bath lids when they are open. They could crush fingers or hands.

4.4.4 Reagent cabinet



Fig. 19

The reagent cabinet holds seventeen reagent bottles and one condensate bottle (→ Fig. 19-1). The bottles are translucent to help you to see the level of reagent in a bottle.

The reagent cabinet is back-lit. If the reagent in a bottle is out of threshold, the light behind this bottle is flashing. Replacing the reagent immediately.

Reagent bottles

The reagent cabinet holds seventeen reagent bottles. There are sufficient reagents to simultaneously schedule protocols in both retorts while also having ample cleaning reagents ready for use. The reagent bottle at each station holds sufficient reagent to fill a single retort.

The reagent bottles are translucent and have color-coded labels. They also have markings on the front showing the minimum level (→ Fig. 20-1) for a run and the maximum fill level (→ Fig. 20-2).

4 Setting up the Instrument



Fig. 20

To remove a reagent bottle, pull the reagent bottle out. Push back in position to return. You will hear a click sound and feel the bottle fitting into its connection point on the back of the cabinet.

You can replace the reagent in a reagent bottle either:

- manually, after having removed the reagent bottle from the instrument, or
- semi-manually, with the reagent bottle still in position in the reagent cabinet but being filled using commands on the [Reagents](#) > [Remote fill/drain](#) screen (→ p. 122 – 7.4 Replacing reagents).

Some chemicals may cause the reagent bottles to expand over time. This is normal and does not affect the performance of the instrument.



Warning

The instrument runs with missing reagent bottles or with loose or missing reagent bottle caps.

People slip or inhale toxic/dangerous fume.

Environment contamination.

- Never run the instrument with missing bottles or with loose or missing bottle caps.
- Never run the instrument without the carbon filter or an external exhaust system, as this will release potentially dangerous fumes into the laboratory.

Condensate bottle

A separate bottle collects condensate fluid. It sits beside the reagent bottles in the lower section of reagent cabinet. Empty the condensate bottle weekly. Do not allow the condensate bottle to overflow, as condensate fluid may contaminate other reagents.

**Warning**

The instrument runs with a missing condensate bottle or with a loose or missing condensate bottle cap.

People slip or inhale toxic/dangerous fume.

Biohazard due to the leak of toxic/dangerous fume.

- Never run the instrument without the condensate bottle or with the loose or missing condensate bottle cap.
- Never run the instrument without the carbon filter or an external exhaust system, as this will release potentially dangerous fumes into the laboratory.

Adhesive labels for reagent bottles

Fig. 21

The labels for reagent bottles come in eight different colors. The colors are adapted to the selectable color palette for the individual reagent groups in the instrument. Make sure to label the reagent bottles according to the station definition on the **Status** screen.

The rectangle labels (→ Fig. 21-1) are applied to the front of the reagent bottles. The round labels (→ Fig. 21-2) are applied to the reagent bottle caps. The surface on the reagent bottles must be clean and dry; then apply the label and press on firmly – especially at the edges. The labels are resistant to the reagents used in the instrument.

4.4.5 Drip tray

Fig. 22

The drip tray is located along with other accessories in the packing box. Push the drip tray (→ Fig. 22-1) under the reagent cabinet.

The drip tray collects reagents that have overflowed or spilled so that no pollution can form in or under the instrument. The volume is not less than 3.88L.

The drip tray must be regularly checked for signs of reagents that have leaked. To do so, pull the tray out by the handle and empty it if necessary, then, push it in.



Warning

The drip tray is not installed or is installed incorrectly and liquid flows onto the floor.

People injury.

Environment contamination.

- Do not use the instrument without installing the drip tray.
- Wear PPE (Personal Protection Equipment) when using the instrument.

4.4.6 Display

A touch-screen mounted on the right of the instrument connects to a computer in the instrument that controls all instrument operations.

Use the touch-screen to configure the instrument, run protocols, and perform ancillary operations such as replacing reagents. Tap buttons and icons with your finger or a blunt object. Do not use sharp objects. Ensure no strong solvents come into contact with the touch-screen.

In its normal operating position, the touch-screen sits over a paraffin bath lid, but it can be rotated to give easy access to the paraffin bath as shown in the figure below (→ Fig. 23). It can also be slightly flipped up and down to meet different users' heights.



Fig. 23

4.4.7 HistoCore I-Scan





Fig. 24

The HistoCore I-Scan sits in a holder mounted on the post that supports the touch-screen. A USB cable is used to supply power and transfer data between the scanner and the instrument.

The scanner provides two main functions, scanning 1D/2D barcode and photographing image. It can be used to quickly enter your ID, the ID on a basket clip (→ p. 43 – Basket clips), the lot number or batch number of a reagent, and photograph baskets.

Three buttons (→ Fig. 24-1) are provided to operate the scanner.

Button	Name	Function
	Fill-in-LED On/off button	Turn on/off the camera lighting.
	Scanning/Photographing trigger button	<p>In the barcode scanning mode, a scanning bar is rolling in the screen, but there is no preview of aimed the barcode. Pressing the trigger button, the scanner starts to scan the barcode. Illumination and aimer light can be seen. The scanner sends recognized barcode content to the instrument once the barcode is recognized successfully. The scanner will show a tick after the instrument receives the data successfully, or a warning mark will be shown.</p> <p>In the photographing mode, LCD displays camera preview. Press the trigger button, then the camera starts to focus and capture an image. A tick is shown after the instrument receives the image successfully, or a warning mark is shown. Hand shake during focusing and image capturing will cause the picture unclear. It takes about 2 seconds for the camera to focus and capture an image.</p>
	Tick button	Confirm the entry and enter the next filling box.

If the recognition of a barcode fails, please try to scan it again. The recommended scanning distance is as follows.

- EAN-13 50mm-200mm (13mil)
- Code39 40mm-90mm (5mil 10 Byte)
- QR Code 25mm-240mm (20mil 16 Byte)
- Data Matrix 50mm-90mm (10mil 20 Byte)
- PDF 417 30mm-130mm (6.67mil 7 Byte)

If the warning mark remains on the screen, disconnect the scanner from the instrument, then reconnect it. If it does not work, restart the instrument. If the problem persists, contact your service representative.

The scanner will sleep if there is no button pressed or no command received in 5 minutes. In the sleeping mode, the LCD display is turned off. Any command from the instrument or pressing button will wake the scanner up.

4.4.8 USB ports

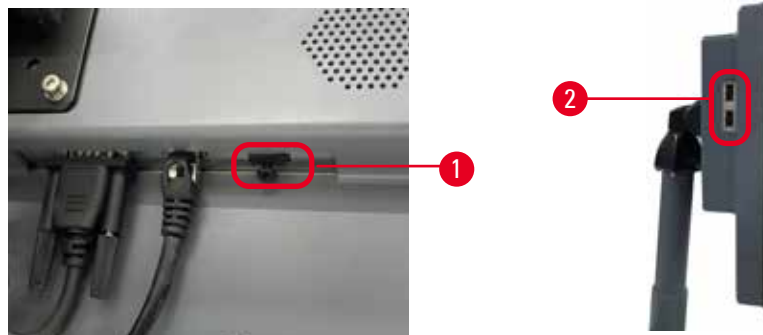

Fig. 25

There are three USB ports on the display, one (→ Fig. 25-1) at the bottom and two (→ Fig. 25-2) on the left side of the display.

The USB port at the bottom of the display is best for the scanner (and this is the default hardware configuration).

The other two USB ports can be used to:

- export logs and incident reports;
- export and import protocol files.

In order to ensure that the instrument is not infected by viruses, it is recommended to use a virus-scanned USB memory stick.

Insert a USB memory stick into the USB port to transfer data. If you are prompted to insert a USB memory stick, your USB memory stick is not recognized by the instrument. Try to reinsert the USB memory stick. If it does not work, check whether there is sufficient space in the USB memory stick or whether it works properly. If the problem persists, use a new one.

4.4.9 Alarm connections



Warning

The local alarm/remote alarm is not connected.
Sample damage
• The remote alarm system/local alarm system shall be connected to the instrument.

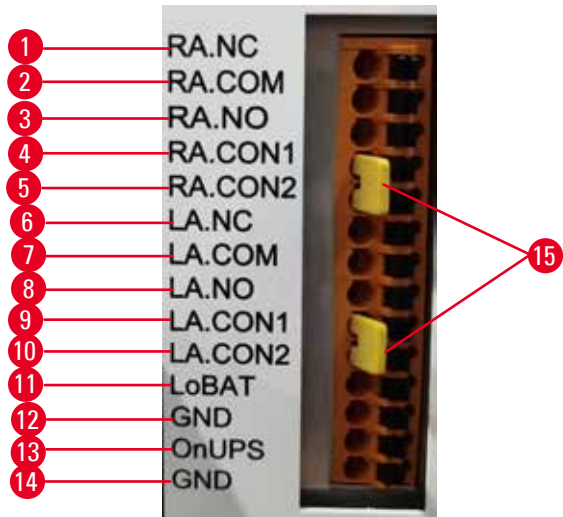

Fig. 26

The instrument provides local and remote alarm interfaces. These connections can be used to control a range of alarm indication devices, including audible alarms, visual alarms, or automatic phone dialers.

The two cross-connectors (→ Fig. 26-15) are intended to inform the instrument whether the alarm system is connected or not. When the instrument is connected to a remote or a local alarm system, the cross-connectors should be plugged in the corresponding RA.CON or LA.CON position. When the instrument is not connected to a remote or a local alarm system, the corresponding cross-connectors must not be inserted, i.e., the configuration as shown by (→ Fig. 26) (connectors inserted while alarms not connected) should never appear on an instrument.

Alarm connector specifications

The load connected to the alarm connector must not exceed the following specifications.

- Maximum voltage: 30 V DC
- Maximum current: 1 A (resistive load)
- Maximum current: 0.5 A (inductive load)

Alarm connector pins

Each alarm connector has three pins.

Remote alarm

RA.NC (→ Fig. 26-1) -- Normally closed; **RA.COM** (→ Fig. 26-2) -- Common; **RA.NO** (→ Fig. 26-3) -- Normally open

Local alarm

LA.NC (→ Fig. 26-4) -- Normally closed; **LA.COM** (→ Fig. 26-5) -- Common; **LA.NO** (→ Fig. 26-6) -- Normally open

Pin schematic during normal operation

When the instrument is operating normally (no alarm) the alarm pins connect as below.

Remote alarm

Pin **RA.NO** -- Normally open; Pin **RA.NC** -- Normally closed and connected to **RA.COM**

Local alarm

Pin **LA.NO** -- Normally open; Pin **LA.NC** -- Normally closed and connected to **LA.COM**

Pin schematic during alarm conditions

When the instrument has an active alarm, the alarm pins connect as below.

Remote alarm

Pin **RA.NO** -- Normally open and connected to **RA.COM**; Pin **RA.NC** -- Normally closed but open during alarm conditions.

Local alarm

Pin **LA.NO** -- Normally open and connected to **LA.COM**; Pin **LA.NC** -- Normally closed but open during alarm conditions.

4.5 Connecting an uninterruptible power supply (UPS)

An uninterruptible power supply (UPS) protects machines and instruments against malfunctions in the power supply. The instrument provides a UPS interface. Use Pins **LoBAT** (→ Fig. 26-11), **GND** (→ Fig. 26-12) **OnUPS** (→ Fig. 26-13) and **GND** (→ Fig. 26-14) to configure a UPS device.

We recommend you to use an active tracking UPS (for example, APC SUA3000 series, with AP9613 Dry Contact I/O SmartSlot Card) to protect the instrument and the specimens from temporary power failure, voltage spikes, under voltages, and excess voltages.

The UPS must be designed for power supply voltage at the installation location. Contact the UPS manufacturer for further advice.

4.6 Switching on and off



Warning

The instrument is plugged into a power board with other instruments.

The instrument may work with unstable current/power, which leads to sample damage.

- Do not use an extension cable.
- Plug the instrument only into a grounded power socket. Make sure an obligatory use of a Circuit breaker.



Warning

Accessories/components may become loose/damaged during transportation

Sample damage

- Before switching the instrument on, visually check the instrument and accessories for any damages possibly caused during transportation or while moving the instrument.

Under normal conditions, keep the instrument on at all times, even when idle for extended periods. Shut it down for servicing or if moving the instrument.

4.6.1 Switching on



Fig. 27

1. Plug the power cord into the mains socket (→ Fig. 27-1).
2. Make sure that the circuit breaker (→ Fig. 27-2) is at the **ON** position.
3. Press On the mains power switch (→ Fig. 27-3) in the front of the instrument. The instrument will take a few minutes to initialize.

4. The login screen appears after the initialization completes. Input the user name and password. and the Status screen is displayed (→ p. 72 – 5.4 Status screen).
5. For the initial login (→ p. 60 – Initial login), use the Administrator account.

4.6.2 Switching off



Warning

Pull out the mains cable or shut down the system while a protocol is running.

Sample damage due to the power failure

- Do not pull out the mains cable whilst the instrument is operating unless there is an emergency situation and both the front panel power button and the mains wall switch are inaccessible.
- Do not shut down the system while a protocol is running.

A normal shutdown shuts down the software in an orderly manner. The instrument must be idle, with no protocols or other operations in progress.

1. Tap the Leica logo on the upright corner of the screen, and tap **Exit**. Or select **Settings > Instrument settings > Exit software**.
2. Confirm the exit. Wait for the touch-screen to go blank and then press the mains power switch.
3. Move the circuit breaker to the **OFF** position to turn it off.
4. Switch the power off at the mains socket and pull out the power cord.

4.6.3 Emergency shutdown

In an emergency, press the mains power switch immediately.

If conditions permit, switch the power off at the mains socket and pull out the power cord.

4.6.4 Restart after long time shutdown

If no longer using the instrument due to maintenance or disposal, the user must first switch off the power supply and then remove the power cable, ensuring that it is stored correctly. In addition, the user must clean the instrument surface, the retort, the reagent bottles, paraffin baths, and the drip tray. If an extraction tube is fitted, it must be removed.

If the instrument is to be restarted, refit the original power cable. Check the retort, reagent bottles, paraffin baths, and drip tray, making sure there are no impurities. If there is an extraction tube, install it as per the instructions. Turn the instrument on and run a validated protocol to ensure the proper functioning of the instrument.

4.7 Moving the instrument



Warning

Lift the instrument without tools or equipment.

The instrument may fall or drop on users when being lifted, which causes people injury.

- Always use suitably rated lifting equipment, such as a trolley or forklift, when moving the instrument upstairs.



Warning

Move the instrument loaded with reagents and paraffin, and/or with power cord connected.

People injury.

- Prior to every transport in which it is possible for the instrument to be shaken, tilted, or lifted, the instrument must be cleaned including the tubing, paraffin baths, and reagent bottles. The power cord must be disconnected.



Warning

Accessories/components/devices may become loose or damaged during transportation.

Sample damage

- Paraffin oven covers must be closed during transportation.
- Retort lids must be locked during transportation.

Before moving, switch off the instrument. The power cord must be disconnected from the mains socket and the instrument is cooled down.

1. Remove the reagent bottles and the drip tray from the instrument.
2. Remove the scanner from the cradle.
3. Release the castors of the instrument.
4. Support the corners of the instrument by hand and push it to a new location.
5. Lock the castors after the instrument has reached the final position.
6. Re-install the drip tray, the reagent bottles, and the scanner.

5. Running Protocol

5.1 Using the software

Instrument functions are controlled from the touch-screen.

5.1.1 Basic operation

Buttons

Tap buttons on the touch-screen to open menus, screens and dialogs, and to start and stop actions. The state of a button is indicated by its color or border. Depending on the screen and the operations available, enabled buttons (→ Fig. 28) could be dark gray, bright blue, bright pink, or bright green. Disabled buttons (→ Fig. 29) are light versions of the base color. Selected buttons have a blue border (→ Fig. 30). Buttons in a toggle pair are dark gray and bright blue.

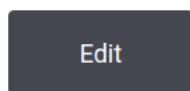

Fig. 28

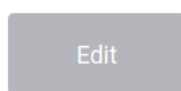

Fig. 29

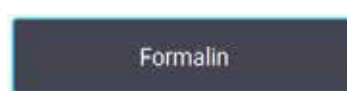

Fig. 30

Icons

Icons are used to represent various elements of the system, such as reagent stations and retorts. Selectable icons (→ Fig. 31) appear raised. Select an icon by tapping it, as you would do to a button. A selected icon (→ Fig. 32) appears raised with a blue border.



Fig. 31



Fig. 32

Keyboards

Keyboards appear as needed to allow you to enter texts and numbers. There are two types: alphanumeric (text and numbers) (→ Fig. 33) and numeric (numbers only). The keyboards are analogous to a computer keyboard with on-screen buttons.



Fig. 33

- | | |
|--|---|
| 1. Text window | 5. Clear button - Remove all characters |
| 2. Texts and numbers | 6. Caps Lock button - select upper or lower case |
| 3. OK and Enter button - Confirm the entry | 7. Shift button - select upper or lower case |
| 4. Back Space button - remove the last character | 8. Cancel button - exit without saving |

5.1.2 Navigation

You navigate throughout the software from the function bar (→ Fig. 34) at the top of the screen.



Fig. 34

The function bar is always visible, so you can always find the screen you want. Tap a button in the function bar to open either a screen or a menu with options for related screens.

Some screens have alternative views to divide the information presented. For example, the **Reagent Stations** screen has two views, one for reagent bottles information and the other for paraffin chamber information. Tap buttons on these screens to move between the alternative views.



In this Instructions for Use, navigation paths are shown in this way: **1 > 2 > 3**





This means from the function bar button, tap **1**, then tap **2** and finally tap **3**. For example, **Administration > Protocols > New** means tap the **Administration** button on the function bar, tap **Protocols** (which will be on the **Administration** menu) and then tap **New** (which will be a button on the **Protocol selection** screen).



Fig. 35

The table below lists all the screens in the software with a brief description of their function. There are also links to relevant sections of this Instructions for Use.

Function bar button	Menu button	Screen purpose	Refer to:
Status 	--	Load and run protocols, and view system status.	(→ p. 72 – 5.4 Status screen)
Reagents 	Stations	Set up reagent stations. You can also view the current reagent concentrations and paraffin bath status.	(→ p. 117 – 7.3 Managing reagent stations)
	Reagent types	Manage your list of active reagent types.	(→ p. 112 – 7.2 Managing reagent types)
	Remote fill/drain	Fill or drain reagent bottles and drain paraffin stations.	(→ p. 122 – 7.4 Replacing reagents)
	Manual operations	Manually control individual instrument components.	(→ p. 131 – 8.1.1 Manual operations)

Function bar button	Menu button	Screen purpose	Refer to:
Administration 	Protocols	Select, create, edit, and manage protocols.	(→ p. 96 – 6.2 Creating, editing, and viewing protocols)
	Favorite protocols	Set favorite protocols	(→ p. 77 – Favorite protocols)
	User management	Manage user accounts.	(→ p. 139 – 8.3 Settings menu)
	Reports	Choose from one of four reports regarding run details, user action, protocol usage, and reagent usage.	(→ p. 134 – 8.2.2 Reports)
	Event logs	View all system events.	(→ p. 138 – 8.2.3 Event logs)
Settings 	Service	View the instrument serial number and software versions, transfer log files and incident reports, and export or import protocol files.	(→ p. 138 – 8.2.3 Event logs)
	Processing settings	Set basic reagent management options.	(→ p. 141 – 8.3.2 Processing settings)
	Instrument settings	Set options for time display, the active carbon filter, and manual operation drip time. Change sound and alarm settings.	(→ p. 143 – 8.3.3 Instrument settings)
	Tracking options	Manage tracking system and the recommended protocols.	(→ p. 146 – 8.3.4 Tracking options)
Maintenance 	--	Record that various maintenance tasks have been completed.	(→ p. 149 – 9.2 Maintenance screen)
		--	Exit the software. Open a PDF version of the Instructions for Use in the software.

5.1.3 Access levels

There are three user-access levels available to laboratory staff: Operator, Supervisor, and Administrator. Operators can carry out all routine tasks, such as running protocols and replacing reagents. However, operators cannot edit protocols or set reagent bottle configurations: you must have supervisor rights for these actions. Supervisors also have rights to configure the system. Administrators have all rights that Supervisors have and can create accounts for supervisors and operators.

Some configuration settings displayed in the software require service-level access to change. These are provided so you can view the settings, but you must contact your authorized service representative if you want to change them.

Initial login

The Administrator account and its password is configured at the factory, which can be used to create new accounts. The default password is admin.

1. The login screen appears after the initialization completes. Tap **Other access** button (→ Fig. 36-1), and select **Administrator**.

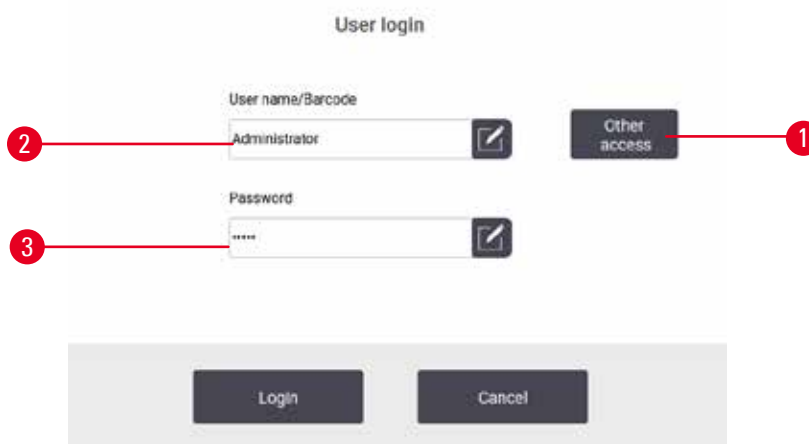

Fig. 36

2. Enter the default password: admin, and tap **OK**. You are required to change the password.
3. Using the keyboard, enter "admin", then enter the new password twice and confirm with **OK**. A password must contain minimum 6 characters, at least one letter and one number. The Status screen is displayed. A label on the function bar indicates your user name (→ Fig. 37-1).

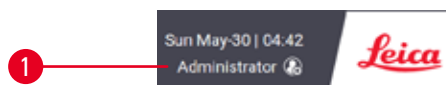

Fig. 37

- ✓ The administrator can now create accounts for supervisors and operators (→ p. 139 – 8.3 Settings menu).

Login

To log in, enter the user name (→ Fig. 36-2) and password (→ Fig. 36-3), then tap **Login**. Or scan the barcode on the name card.

Switch user/Logout

1. Tap the user name (→ Fig. 37-1) on the function bar.
2. Select **Switch user** or **Logout**.
3. Proceed with the next action of choice.

The default automatic logout time is 15 minutes. To change the automatic logout time, go to **Settings > Service > Lock screen**.

5.1.4 Help

The Instructions for Use is provided in PDF format on a data carrier. It is also included (in PDF format) in the instrument software. Tap the **Leica** logo in the function bar to open it. On some screens, tap **Help** to open the specific help page of that screen.

5.2 Quick start



Warning

Accessories/components may become loose/damaged during transportation

Sample damage

- Before processing patient tissue samples after transportation or moving the instrument, perform a test run to ensure the suitability of the instrument and the protocol used. Either use a pre-defined protocol or combine this activity with the validation of your own protocols.
- Only process patient tissue samples for diagnostic purposes, after all the above checks have been performed successfully. If any of the previous steps failed, do not operate the instrument and contact your local Leica Biosystems Service Representative.



Warning

User-defined protocols not validated.

Sample damage

- The pre-defined protocols and the customized protocols have to be validated by the user before running the protocol, i.e. tissue processing with patient tissue for diagnostics, according to the local or regional accreditation requirements.



Warning

The retort is not empty before remote fill.

Sample damage.

- Check the retort and make sure nothing is left in the retort before running a protocol.
- Ensure the reagent bottle is properly connected and the liquid level in reagent bottle is between the maximum and minimum indicator.

5 Running Protocol



Warning

Open retort while the instrument is processing/after pausing/after the protocol ends, the user gets contact with the hot surface of lid/baskets/fluids/hazardous reagents/vapor from the retort.

Open the retort and the protocol cannot continue.

People injury/Sample damage/Impaired samples

- Hot surface. Wear chemical protective clothing, protective goggles, respirator, rubber gloves, and all other necessary personal protective equipment during operation.
- Do not open the retort lid or remove reagent bottles/paraffin oven cover/paraffin baths when a protocol is running, unless a system message indicates to do so. Whilst a protocol is running, if you want to remove the specimens from the retort or add specimens to the retort, press the pause button.
- Take care if opening a retort or paraffin bath after pausing the instrument. Read any warning messages—for example, the retort is above safe access temperature—and take appropriate precautions before continuing.
- Molten paraffin is hot and may cause burns. Be careful when handling paraffin and removing baskets.



Warning

Processing starts when paraffin is not completely melted.

Sample damage

- Make sure that the paraffin in the paraffin baths is completely melted before pressing the Start button.



Warning

Samples are not covered by reagents/paraffin.

Samples dried out and got damaged.

- Before running the protocol, check the reagent level in reagent bottles from the outside. Make sure that reagents level is between Min. and Max. marks. Check the paraffin levels as well.
- Do not add samples over the level sensor.
- Do not add specimens more than suggested.
- Always ensure the cassettes are correctly inserted into the baskets and that the baskets are correctly placed in the retorts.
- Station selection protocols are not recommended for overnight processing. If a reagent becomes unavailable for any reason, then the protocol cannot finish.



Warning

Blockage by losing cassettes/tissues from retort or impurities from reagents or paraffin

Sample damage

- Use baskets during processing. Do not put the specimens into the retort directly.
- Check that the retort filter is installed at the retort bottom before running a protocol.
- Take care not to drop anything into the retort when the retort filter is removed. Foreign material in the pipes could stop valves from operating properly.

Before you begin, all the reagents you need must be configured (→ p. 117 – 7.3 Managing reagent stations). Further, for users with operator-level access only, there must be at least one validated protocol ready to load (→ p. 96 – 6.2 Creating, editing, and viewing protocols). Front castors brakes must be locked. Do not move the instrument while a protocol is running.

Instrument checks and setup

1. Tap the **Status** button to display the **Status** screen. All protocols run beginning from the **Status** screen (→ Fig. 45).
2. Check that the retort icon (→ p. 73 – Retort icons) you want to use shows that the retort is either clean or has residue of a reagent compatible with the first reagent of the protocol.
3. If necessary, replace any reagent, or the paraffin in a paraffin bath, that needs to be replaced (→ p. 122 – 7.4 Replacing reagents). The standard icons for reagents and paraffin baths will have been modified in various ways if replacement is needed or recommended. See Bottle icons (→ p. 75 – Bottle icons) and Paraffin bath icons (→ p. 74 – Paraffin bath icons).
4. Check that the instrument is ready:
 - A. All 17 reagent bottles and the condensate bottle must be properly installed on the instrument.
 - B. There must be enough reagent in the reagent bottles and paraffin baths. Fill the reagent bottles and paraffin baths to the level between **MIN** and **MAX** marks.
 - C. Open the retort to use. Check that it is clean, or that any residue is a reagent compatible with the first reagent in the protocol.
5. Prepare your cassettes and load them into baskets (→ p. 42 – 4.4.2 Cassette baskets).

Load protocol

With different settings of tracking functions, there are three options to run a processing protocol.

- Option 1: Run a processing protocol without tracking
 - Option 2: Run a processing protocol with tracking functions enabled
 - Option 3: Run with the recommended protocol
6. Run a processing protocol without tracking.
 - A. Select a protocol on the favorites list panel or tap the **...More** button at the bottom left (for retort A) or bottom right (for retort B) to select a protocol from the **Protocol selection** screen. Only validated protocols (indicated by a green tick) (→ Fig. 38-1) can be selected by operator-level users.

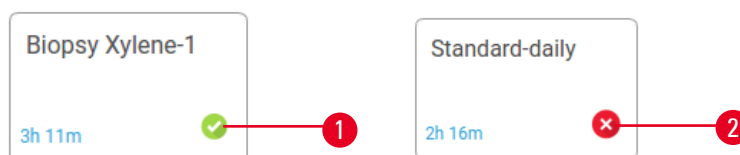

Fig. 38

5 Running Protocol

- B. If the first step of the protocol uses a reagent that is incompatible with retort residue, a warning message is displayed. You may need to run a cleaning protocol or you may be able to skip the first steps of the protocol (→ p. 82 – 5.5.2 Changing the starting step for a single run). If so, tap **Clear all** in the warning dialog box to continue.
 - C. If you want to add a note to the protocol, tap **Add note**. Using the on-screen keyboard, type your note and tap **Enter** or **OK**. Notes can also be added to a protocol while the protocol is running.
 - D. Tap the **Run** button. Continue with step 9.
7. Run a processing protocol with tracking options enabled. In this option, the instrument must work with the HistoCore I-Scan, and the tracking functions are enabled (→ p. 146 – 8.3.4 Tracking options).
- A. Follow steps 6A, 6B, and 6C above.
 - B. Tap the **Run** button. The **Retort A/B baskets** screen appears.
 - C. Enter the information of Basket 1. To do so, press the Fill-in-LED On/Off button (→ Fig. 39-1) on the scanner to turn on the scanner lighting. Pressing the Scanning/Photographing trigger button (→ Fig. 39-2), the barcode scanner starts to scan the barcode. Once the barcode is recognized successfully, a tick shows on the scanner screen. The barcode information is filled in the Basket 1 name field (→ Fig. 39-4) and the next filling box is enabled (→ Fig. 39-5). Take the picture for the basket by pressing the Scanning/Photographing trigger button. View the basket picture on the right side of the screen (→ Fig. 39-6). Adjust the picture using the picture view tools (→ Fig. 39-7). Press the Tick button (→ Fig. 39-3). Then, enter the information of Basket 2 (→ Fig. 39-8) in the same way.
 - D. When you are finished, tap **OK**. Continue with step 9.

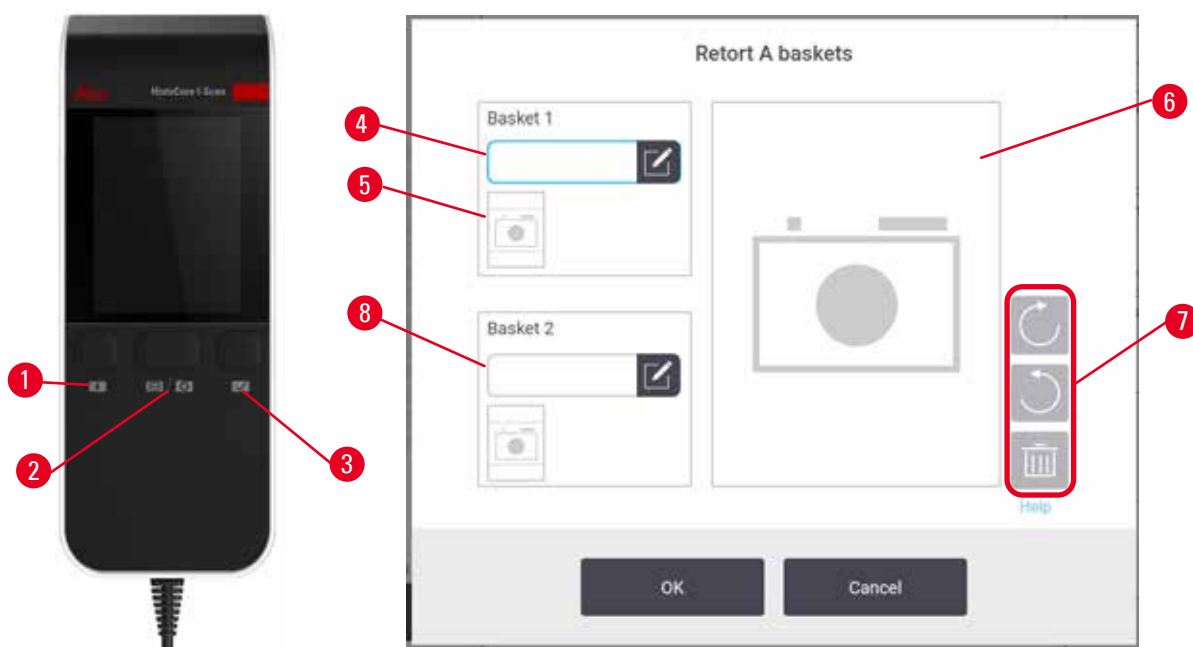

Fig. 39

8. Run with the recommended protocol. In this option, the instrument must work with the HistoCore I-Scan, the tracking functions are enabled, and the basket has been linked with a recommended protocol (→ p. 146 – 8.3.4 Tracking options).
 - A. Tap the scanner buttons (→ Fig. 45-2) (→ Fig. 45-7).
 - B. Scan the barcode and take the picture for the basket. Refer to step 7C.
 - C. When you are finished, tap **OK**. Continue with step 9.

9. Place the baskets into the required retort and firmly close the retort lid.

Run protocol

10. A dialog box (→ Fig. 40) appears for you to enter the number of cassettes that are in the retort.

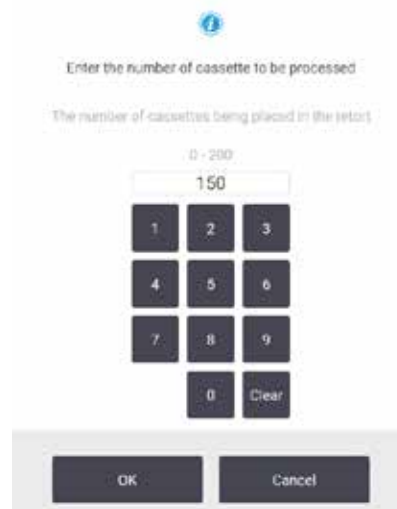

Fig. 40

The number displayed by default is set by supervisors (→ 8.3.2 Processing settings). However, it is important that you enter the correct number of cassettes. The figure you enter is used by the reagent management system to calculate reagent concentrations. Enter the number and tap **OK**. The scheduling screen will now appear.



Fig. 41

11. If you want to edit any steps in the protocol, or change the duration of a step, tap **Edit steps**. The process is explained in ([→ p. 82 – 5.5.2 Changing the starting step for a single run](#)).
12. If you want to run the protocol immediately, tap **ASAP** and continue with step 15 below.
13. If you want to delay the start of the run:
 - A. by a full day, tap **+Day**
 - B. by any other time, tap **Edit end time** and specify a delay ([→ p. 80 – 5.5.1 Scheduling protocols](#)).
14. Check that the predicted end time shown on the screen is acceptable. If it is not, repeat from step 12 above.
15. Tap the **Start** button, and the system schedules the protocol.
 - A. If the system is unable to schedule the protocol, warning messages will appear. Tap **Clear all** and correct all errors before attempting to run the protocol again ([→ p. 88 – 5.7.2 Unavoidable reagent clashes](#)).
 - B. If the system was able to schedule the run, the protocol will begin.
 - C. If you have set a delayed end time, an initial fill condition will occur ([→ p. 88 – 5.7.1 Delayed end times and initial fills](#)).

You can view the progress of the run on the **Status** screen. You can pause the protocol run to add additional cassettes, or abort the run completely ([→ p. 85 – 5.6 Pausing and aborting protocols](#)).

Finish protocol run

16. When the protocol is finished the **Protocol complete** dialog box appears and an alarm sounds.



Fig. 42

You can remove the baskets before draining the retort, although this option is not recommended. To do so, tap **Access now**. To drain the retort, tap **Drain retort**.

17. When prompted to, open the retort.

18. A message appears prompting you to remove all tissues. Do so and tap **Done**.

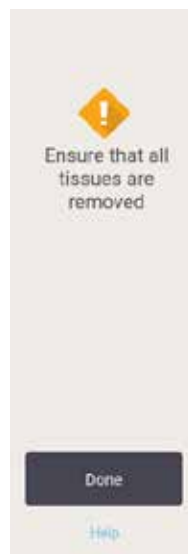

Fig. 43

Do not tap **Done** until all baskets have been removed from the retort.

5 Running Protocol

Run cleaning protocol

19. The Clean now panel is now displayed. Run a cleaning protocol before running the next processing protocol.



Warning

Tissues are left in the retort when running the cleaning protocol.

Sample damage

- Remove all tissues from the retort before running a cleaning protocol as the dry step will damage the tissue.

20. If you want to accept the preselected default protocol for cleaning, tap **Start** and continue from step 23 below. Otherwise, select the cleaning protocol and run it just as you would do to a tissue-processing protocol (as described in this procedure).
21. You are prompted to place your dirty baskets in the retort. Make sure that all tissue has been removed from the baskets before you do so. Tap **OK** when you have placed the baskets in the retort and closed the lid of the retort.
22. If you want to edit the steps in the cleaning protocol, tap **Edit steps**. ([→ p. 82 – 5.5.2 Changing the starting step for a single run](#)).
23. Tap **Start** to begin the run.
24. When the protocol is finished, the **Protocol complete** panel appears and an alarm sounds. Tap **Access now** to continue.
25. When the **Access retort now** panel appears, open the retort lid and remove the baskets.
26. Tap **Open retort** to continue.

5.3 Cleaning protocols

Cleaning protocols clean the retorts and common reagent lines. You can select the **Clean now** option when prompted at the end of a run. This runs the pre-defined cleaning protocol (called **Quick Clean**). Alternatively, you can choose another cleaning protocol.

You should also clean retorts:

- after replacing reagent using the remote-fill-and-drain functionality
- if you filled them manually, and/or
- if the last reagent is not compatible with the next protocol to be run ([→ p. 169 – 10.5 Reagent compatibility tables](#)).

For most laboratories, the pre-defined **Quick Clean** protocol should be the only cleaning protocol required. Under normal conditions, the protocol purges residue in the retort to the paraffin bath before the first step. Then there are two reagent steps: cleaning xylene and cleaning ethanol. These are followed by a dry step. This step applies high temperature, vacuum and air flow to evaporate any reagent residue. At the end of the dry step the heaters turn off but air flow continues to cool the retorts.

Load and run cleaning protocols as you would other protocols, but never with tissue in the retort. The dry step will damage it. This means that cleaning protocols should never be used for reprocessing runs. Use a reprocessing protocol instead.

If required, create your own cleaning protocols.

To create new cleaning protocols, do as follows.

1. Open the **Protocol selection** screen (**Administration > Protocols**) and tap **Cleaning**.
2. Tap **New**, and select **Cleaning** as the protocol type.
3. Enter a name for the cleaning protocol.
4. Choose a reagent selection method, **Type** or **Station**. A series of dialog boxes will now guide you through creating the first step.
 - » Cleaning protocols automatically have a final dry step. You cannot edit this step.
5. Tap the second row in the protocol table, and tap **Insert** to add the second step. Add further steps as required.
6. Optionally tap the **Name** button to edit your cleaning protocol name.
7. Optionally tap the **Notes** button to add any information you want to keep with the protocol.
8. Tap the **Save** button to save the protocol.
9. Tap the **Done** button to finish.
10. The window appears warning you of any actions that are required or recommended before the protocol can be used. One warning always listed is that the protocol is not validated for use. By default, a newly created protocol is not a valid protocol. Your laboratory will need to validate it before clinical use. Once validated, a supervisor can go to the **Edit protocol** screen and tap the **Validate protocol** button. The protocol then becomes available to operators (provided that any other errors listed on the window have been attended to). Tap the **Default** button to set the cleaning protocol as a default cleaning protocol, if needed.

To create your own cleaning protocols by copying the pre-defined **Quick Clean** protocol, do as follows.

1. Tap **Administration > Protocols**, and tap **Cleaning**.
2. Select the **Quick Clean** protocol, and tap **Copy**.
3. Enter a new name for your protocol.
4. Modify the cleaning protocol (→ p. 96 – 6.2.2 Editing protocols). You cannot edit the final dry step in cleaning protocols.
5. Continue with step 6 of creating a new cleaning protocol above.

Cleaning protocols do not require a water step and work well with conventional cleaning reagents.

To completely remove xylene from your instrument, Leica Biosystems can supply Waxsol™, a xylene-free cleaning solution (→ p. 109 – 7.1.4 Recommended reagents).

**Warning**

Tissues are left in the retort when running the cleaning protocol.

Sample damage

- Remove all tissues from the retort before running a cleaning protocol as the dry step will damage the tissue.

**Warning**

Use cleaning protocol for sample reprocessing.

Sample damage

- Do not use cleaning protocols for reprocessing as the dry step will damage the tissue.

**Warning**

Use wrong/insufficient cleaning tools / reagents

Sample damage

- Do not reuse contaminated dehydrants as cleaning ethanol. The contaminated dehydrants will contain formalin (or other fixatives) and the dry step will cause salts to crystallize on the retort's internal surfaces.
- Always run a cleaning protocol after paraffin has been in the retort.

All the pre-defined cleaning reagents have cycle purity thresholds. These thresholds force reagents to be replaced after ten or six cleaning runs (if they do not exceed a concentration threshold first). But the thresholds are designed for cleaning runs with only cassette baskets in the retorts.

**Warning**

Run cleaning protocol to clean additional materials other than baskets.

Impaired samples - Cleaning reagents degenerate at a faster rate. If the cycle purity threshold is not lowered, the low purity cleaning reagents leads to low-quality cleaning.

- Do not clean other materials using cleaning protocol.

Modifying cleaning protocols for different retort residues

Always run a complete cleaning protocol as soon as possible if paraffin or clearing reagents are left in the retorts.

For ethanol or formalin residue, skip the first step of the protocol and start at the ethanol step (→ p. 82 – 5.5.2 [Changing the starting step for a single run](#)).

A residue of clean formalin can be allowed to stay in a retort if the next processing protocol begins with a formalin step. If you are left with formalin in a retort at the end of a protocol, you can continue without cleaning if required. When the **Clean now** panel appears, the default cleaning protocol is preloaded, ready to run. To bypass this cleaning protocol:

1. Tap **...More**.
2. Tap any tissue-processing protocol and tap **Load**.
3. Tap **Run**.
4. Tap **Unload protocol**.
5. Proceed with the next action of choice.

Pre-cleaning purges

Cleaning protocols are generally run to clean paraffin residue from the retorts, as paraffin is the final step of processing protocols. To help maximize the useful life of the cleaning solvent, the instrument usually purges any paraffin residue from the retort to the paraffin chamber it came from before the cleaning protocol begins.

If you attempt to load a processing protocol to a retort with incompatible residue in it, you are warned with event 10011: "Incompatible reagent in retort. Clean retort or edit protocol." A cleaning protocol run after this warning will not have the normal purge to the paraffin chamber. This is in case fresh cassettes were placed in the retort, contaminating the paraffin residue with formalin. A purge under these conditions would contaminate the paraffin path with formalin.

If you ever place fresh cassettes into a dirty retort in preparation for processing, remove the cassettes and then attempt to load a processing protocol before loading the cleaning protocol. The 10011 warning raised when you attempt to load the processing protocol causes the cleaning protocol to skip the paraffin bath purge. The retort residue, now with formalin in it, will not go into the paraffin bath but into the cleaning solvent.

After the cleaning protocol finishes, replace the cleaning solvent (as it will now be contaminated with formalin). In general, avoid this situation by always cleaning the retort immediately after a processing run. You will be prompted to do so. Do not put fresh cassettes into a retort that is showing residue in it, as indicated by the icon below (→ Fig. 44). (Formalin residue may be acceptable).



Fig. 44



Warning

Unprocessed samples (with formalin residue) are placed into a retort prior to running a cleaning protocol.

Impaired samples - Formalin in the residue purged to the paraffin bath at the start of the cleaning run may damage tissue on subsequent runs.

- Do not load unprocessed tissue samples into a retort prior to running a cleaning protocol.
- If you inadvertently load unprocessed samples into a retort prior to running a cleaning protocol, remove the samples and attempt to load a processing protocol before loading the cleaning protocol. The purge before the cleaning run will be skipped.

5.4 Status screen

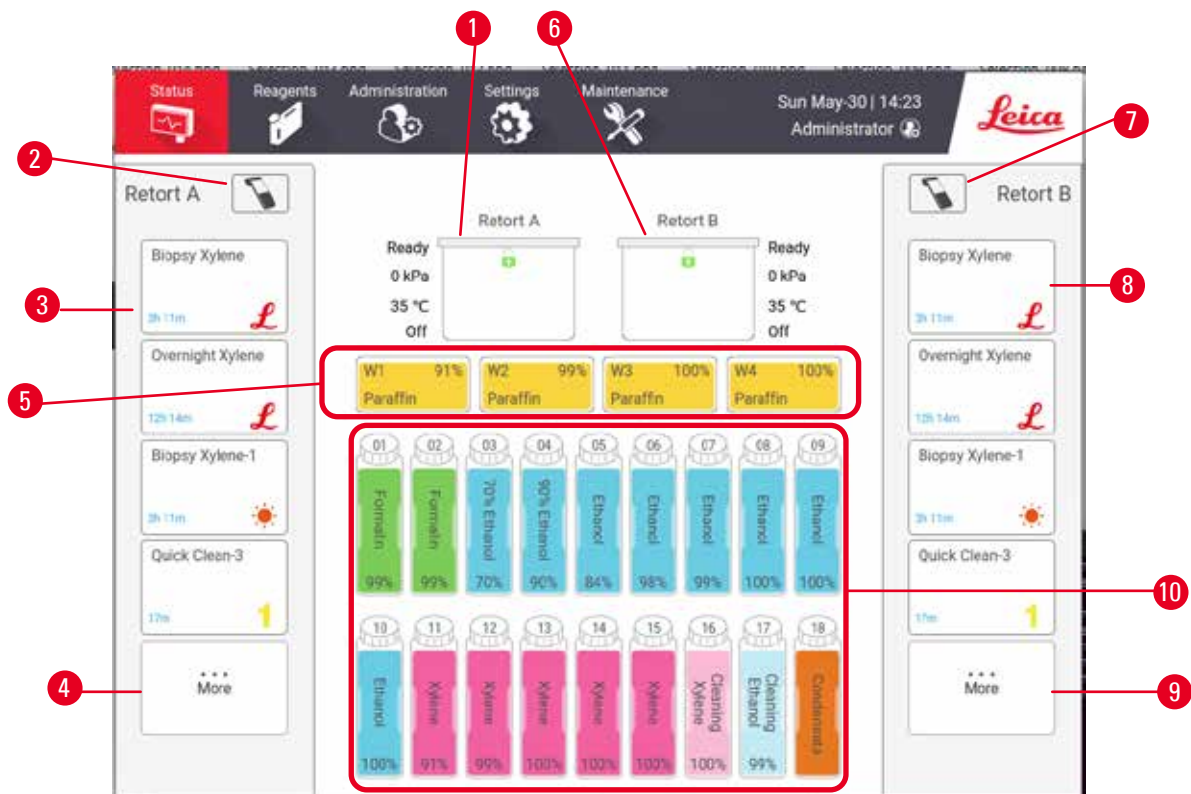

Fig. 45

- | | |
|---|---|
| 1. Retort A | 6. Retort B |
| 2. Scanner button of Retort A | 7. Scanner button of Retort B |
| 3. Favorite protocol panel of Retort A | 8. Favorite protocol panel of Retort B |
| 4. ...More button of Retort A (to view all protocols) | 9. ...More button of Retort B (to view all protocols) |
| 5. Paraffin baths (W1-W4) | 10. 17 reagent bottles and 1 Condensation bottle |

The **Status** screen is where you load and run protocols, and monitor a protocol's progress.

5.4.1 Status area

The central area of the screen shows the status of retorts, paraffin baths, reagent bottles and condensation bottle.

Retort icons

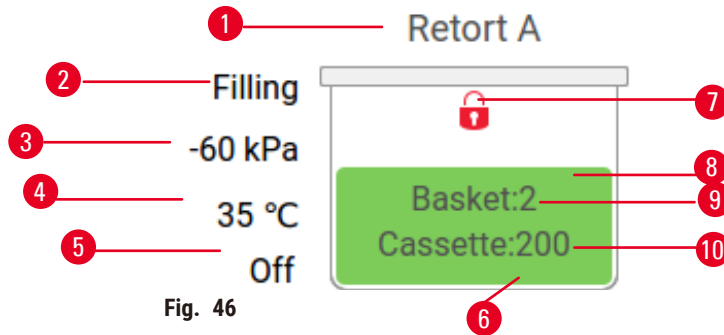

Fig. 46

- | | |
|--|--|
| 1. Retort name | 7. Retort lock status |
| 2. Current retort operation | 8. Color or other pattern shows retort state |
| 3. *Retort pressure | 9. The number of baskets for which an ID has been entered. |
| 4. *Retort temperature | 10. The number of cassettes in the retort |
| 5. *Stirrer On/Off | |
| 6. Color-coded for reagent group currently in the retort | |







*These retort statuses are not shown after 10 minutes at the operator level or when logout.

The Current retort operation (→ Fig. 46-2) could be:

- **Ready** – the retort is available for any new action
- **Reserved** – a protocol is loaded but has not yet started
- **Processing** – the retort is currently running a protocol
- **Completed** – the retort has completed the loaded protocol
- **Drying** – the retort is being dried as the final step of a cleaning protocol
- **Filling** – the retort is currently filling
- **Draining** – the retort is currently draining
- **Pending** (drain or fill) – the retort is waiting for resources to perform a fill or drain
- **Aborting** – the retort is aborting the current action
- **Unavailable** – the retort cannot be used. Contact your service representative.

The retort has six possible states (→ Fig. 46-6).

Icon	Retort state	Description
	Full	The retort contains the correct amount of reagent or paraffin.



Icon	Retort state	Description
	Part full	The reagent or paraffin level is between full and empty. This usually occurs during a fill or drain operation.
	Empty	The retort is drained but contains residue.
	Clean	There is no residue in the retort. This only occurs after a cleaning protocol. The retort is now ready for another protocol run.
	With identified baskets	The retort is ready for another protocol run and the ID of at least one of the baskets for the run has been entered. The number indicates the number of baskets for which an ID has been entered.
	Protocol run finished successfully; awaiting tissue removal	A protocol run has been completed but you are yet to confirm that all tissue has been removed from the retort.
	Protocol run finished successfully	A protocol run has been completed, but the retort has not been drained.
	Full without basket	Manual-fill reagent completed.

Paraffin bath icons

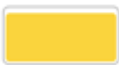
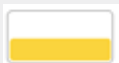
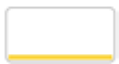

1. Paraffin bath number
2. Reagent type (i.e. type of paraffin)
3. Color-code: orange for reagent group "Paraffin"
4. Paraffin concentration
5. Color or other pattern shows station state

Paraffin baths have four possible station states:

Icon	Paraffin baths state	Description
	Full	The paraffin bath has enough paraffin to fill a retort.
	Part full	A paraffin transfer is in progress or has been aborted. The paraffin level is between full and empty.
	Empty	The paraffin bath has been drained to fill a retort. There is still paraffin in the paraffin bath.
	Not molten	The paraffin in the paraffin bath has not melted and is unavailable.

Bottle icons



Fig. 48

1. Bottle number
2. Reagent type
3. Color-coded by reagent group (see (→ p. 103 – 7.1.1 Reagent groups, types, and stations))
4. Warning symbol and cross-hatching shows reagent is out of threshold
5. Color or other pattern shows station state (see below)
6. Reagent concentration

Icon	Bottle state	Description
	Full	The bottle holds sufficient reagent to fill a retort at the specified basket level.
	In use	A reagent transfer is in progress or was aborted. The reagent level is between full and empty.
	Empty	The bottle has been used to fill a retort. There is still reagent in the bottle.
	Dry	The bottle has been completely drained leaving only a small amount of residue.
	No bottle	The bottle has been removed.
	Unknown	A previously missing bottle has been replaced. You must enter the reagent and state details before using this station.

5.4.2 Protocol panels

Favorite protocols

Up to 4 protocols can be selected as favorite protocols showing on the **Status** screen for the retort. Retort A and B have the same favorite protocol list.

To set a protocol as the favorite protocol, follow these steps.

1. Go to **Administration > Favorite protocols**.
2. Tap the **Add** button (→ Fig. 49-1).

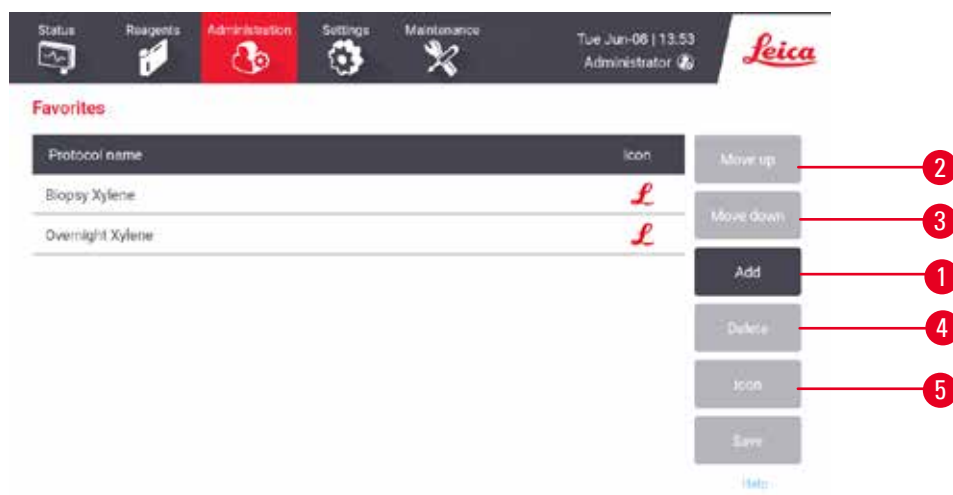

Fig. 49

3. Select a protocol you want from the **Protocol selection** list. Tap the **Select** button on the right side of the screen.
4. The **Select icon** dialog box appears (→ Fig. 50). Select an icon for the protocol from the list, and tap **OK**.



Fig. 50

5. The selected protocol shows in the **Favorites** list. Tap **Save** on the **Favorites** dialog box, and the selected protocol shows on the **Status** screen for both retorts.

Tap **Move up** (→ Fig. 49-2) or **Move down** (→ Fig. 49-3) buttons to adjust the sequence of favorite protocols showing on the **Status** screen. Tap the **Delete** button (→ Fig. 49-4) to remove a favorite protocol from the **Status** screen. Tap the **Icon** button (→ Fig. 49-5) to change the icon for the favorite protocol.

Protocol panels

When you select a protocol either from the favorite protocols list or from the protocol selection list, protocol steps show on the **Status** screen for each retort. Use the panels to load and unload protocols, start a processing run, and pause a run. You can also monitor the progress of a run.

You can view the panels in two modes: standard (→ Fig. 51) and expanded (→ Fig. 52).

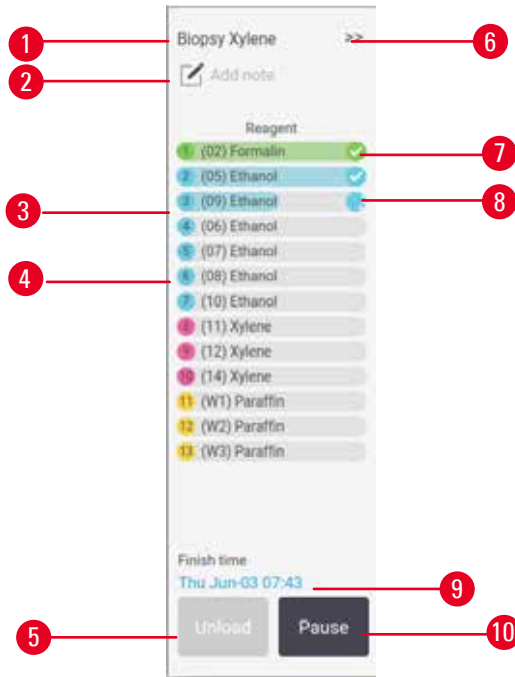

Fig. 51

- | | |
|---|---|
| <ol style="list-style-type: none"> 1. Protocol name 2. Note space 3. Protocol steps 4. The station scheduled for the step (a different station may be used) 5. Unload protocol: unload protocols (disabled while the protocol is running) | <ol style="list-style-type: none"> 6. Extended mode: tap arrow to expand protocol panel 7. The completed step is checked 8. Shaded progress bar shows progress through the current step 9. Protocol finish time 10. Run/Pause: start a loaded protocol, or pause a running protocol |
|---|---|

In the expanded mode, the protocol notes, processing time, and step details are also shown.



Fig. 52

1. Step duration, temperature, P/V(Pressure/Vacuum), and stirrer ON/OFF
2. Processing time: total time to run protocol

5.5 Protocol run options

You can schedule a protocol run so that it finishes at a convenient time. You can also modify the protocol to start at the second or later steps, and to change step durations.

5.5.1 Scheduling protocols

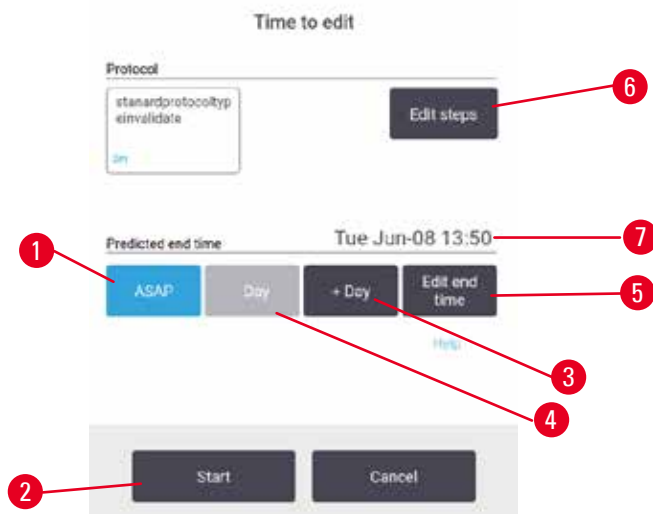

Fig. 53

You schedule a protocol run in the **Time to edit** dialog box (→ Fig. 53). The dialog box opens after you have loaded the protocol, input baskets ID, and input the number of cassettes (→ p. 82 – 5.5.2 [Changing the starting step for a single run](#)).

Each retort has a default scheduling setting (→ p. 82 – [Entering a new end time or default scheduling setting](#)). You can accept the default or change the setting for the run: there are options to set a different end time or run the protocol as soon as possible (the **ASAP** option) (→ Fig. 53-1). You can also change the retort default time.

The system considers the required end time as the latest acceptable protocol completion time. To avoid resource clashes, protocols may be scheduled to finish earlier than the required end time.

The required end time for cleaning protocols is always set to **ASAP**.



Note

- Before starting a protocol, always check that the predicted end time is suitable.

How to schedule a protocol run

When the **Time to edit** dialog box opens, the retort's default scheduling is shown.

- If the default end time is set to **ASAP** the protocol is scheduled to end at the earliest possible time.
- If the default setting is a specific time of day, the dialog box defaults to that time on the following day.

You have four options:

- Accept the default values as they are. Edit the protocol for the run if required (→ p. 82 – 5.5.2 [Changing the starting step for a single run](#)) and then tap **Start** (→ Fig. 53-2) to begin the run.
- Keep the default time but change the day the protocol will run. Tap the **+ day** (→ Fig. 53-3) or **- day** (→ Fig. 53-4) button to keep the default end time but change the day. If the default setting is a specific time of day, the dialog box opens with the run set to the following day. To run the protocol on the current day tap the **- day** button once. Depending on the time you do this, the new end time may not be possible. If so, the Predicted end time (→ Fig. 53-7) is highlighted in red.
- Start the run as soon as possible. Tap the **ASAP** button. The protocol will normally start immediately. However, if there is a reagent clash caused by the protocol running in the other retort, the actual start of the protocol may be delayed (→ p. 88 – 5.7.1 [Delayed end times and initial fills](#)).
- Set a new end time. Tap the **Edit end time** (→ Fig. 53-5) button to open the **Enter required end time** dialog box. (See the next section for instructions.)

5 Running Protocol

Entering a new end time or default scheduling setting

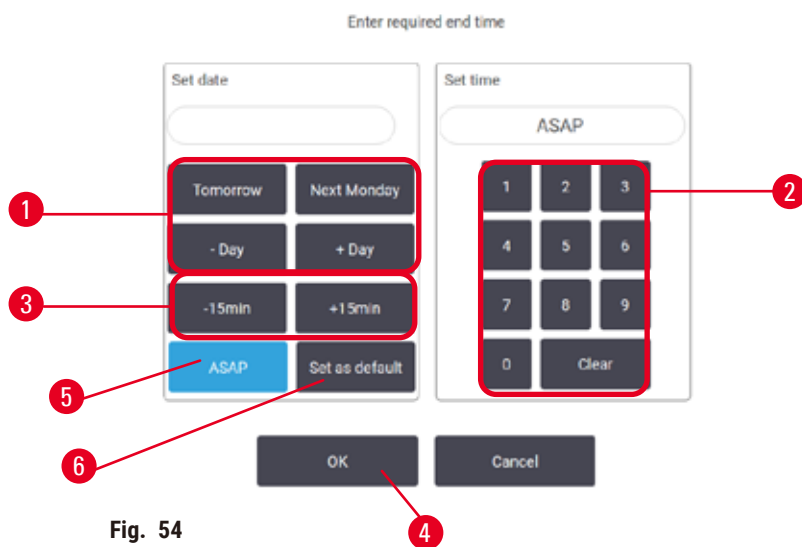

Fig. 54

You can change the end time for the currently selected run in the **Enter required end time** dialog box (→ Fig. 54), opened from the **Time to edit** dialog box by tapping the **Edit end time** button (→ Fig. 53-5).

You can also specify that a scheduling setting becomes the new default for the current retort.

- To set a new date, Use the **Tomorrow**, **Next Monday**, **+ Day** and **- Day** buttons (→ Fig. 54-1) to change the day. To set a new end time, use the numeric keyboard (→ Fig. 54-2) to enter the time (in 24-hour format) or use the **-15min** or **+15min** buttons (→ Fig. 54-3) to increment the time in 15-minute steps. Tap **OK** (→ Fig. 54-4) when finished.
- To set a new retort scheduling default, enter a time of day (as you would to change the end time for an individual run) or tap **ASAP** (→ Fig. 54-5). The day is not relevant to the default setting. Tap **Set as default** (→ Fig. 54-6) then **OK**.

5.5.2 Changing the starting step for a single run

After selecting a protocol, and just before the protocol starts, you can change the step from which it starts.

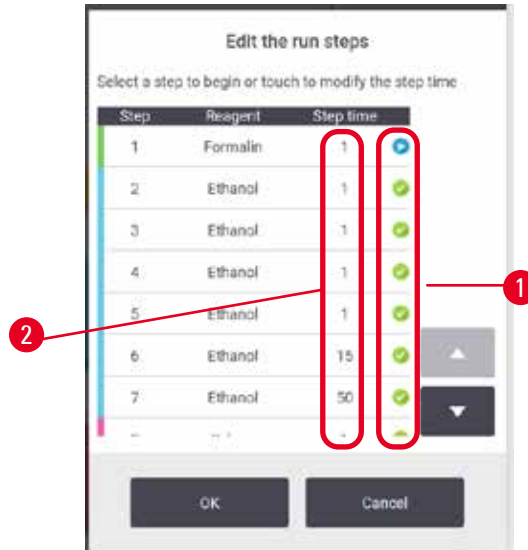

Fig. 55

1. Start a protocol run as normal from the **Status** screen and continue until the **Time to edit** dialog box (→ Fig. 53) opens. Tap **Edit steps** (→ Fig. 53-6) to open the **Edit the run steps** dialog box (→ Fig. 55).
2. To skip one or more protocol steps, tap the step icon (→ Fig. 55-1) for the step that you want the protocol to start with. The step icons of steps prior to this disappear to show they will not run. The reagent selected as the new first step will be used for the initial fill, if required (→ p. 88 – 5.7.1 Delayed end times and initial fills).
3. Tap **OK**. The **Time to edit** dialog box appears. You can now schedule the run.

**Note**

- Skipping steps will affect protocol scheduling. Confirm that the new Predicted end time shown in the Scheduling dialog box is acceptable before continuing.
- If you want to revert to the original protocol at this stage, you will need to unload the changed protocol and re-load the original.

5.5.3 Changing the step time for a single run

After selecting a protocol, and just before the protocol starts, you can change the duration of one or more steps in the protocol.

1. Start a protocol run as normal from the **Status** screen and continue until the **Time to edit** dialog box (→ Fig. 53) opens. Tap **Edit steps** (→ Fig. 53-6) to open the **Edit the run steps** dialog box (→ Fig. 55).
2. To change a step time, tap the current step time (→ Fig. 55-2).
3. Set a new duration in the dialog box.



Fig. 56

4. Tap **OK** and repeat from step 2 above if you want to change any other step duration.

**Note**

- Be careful not to tap a step icon at the right of the dialog box. Tapping a step icon could change the protocol's starting step.

5. Tap **OK**. The **Time to edit** dialog box appears. You can now schedule the run.

**Note**

- Changing step durations will affect protocol scheduling. Confirm that the new **Predicted end time** shown in the Time to edit dialog box is acceptable before proceeding.

5.6 Pausing and aborting protocols

**Warning**

Open retort while the instrument is processing/after pausing/after the protocol ends, the user gets contact with the hot surface of lid/baskets/fluids/hazardous reagents/vapor from the retort.

Open the retort and the protocol cannot continue.

People injury/Sample damage/Impaired samples

- Hot surface. Wear chemical protective clothing, protective goggles, respirator, rubber gloves, and all other necessary personal protective equipment during operation.
- Do not open the retort lid or remove reagent bottles/paraffin oven cover/paraffin baths when a protocol is running, unless a system message indicates to do so. Whilst a protocol is running, if you want to remove the specimens from the retort or add specimens to the retort, press the pause button.
- Take care if opening a retort or paraffin bath after pausing the instrument. Read any warning messages—for example, the retort is above safe access temperature—and take appropriate precautions before continuing.
- Molten paraffin is hot and may cause burns. Be careful when handling paraffin and removing baskets.

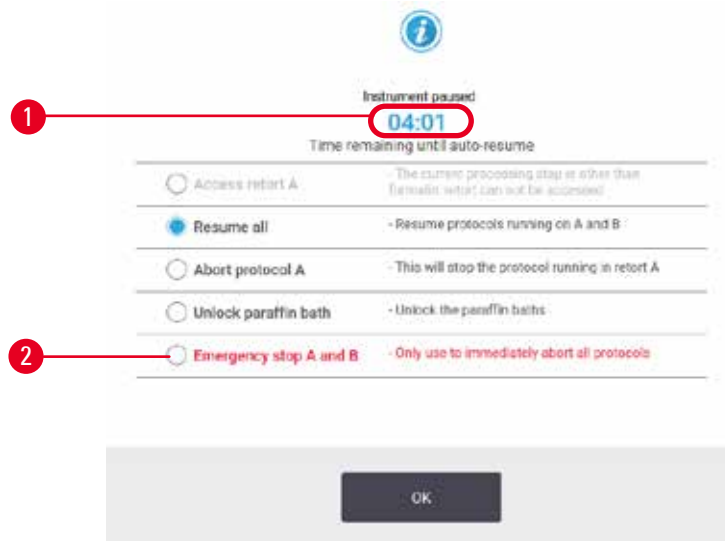

Fig. 57

To stop a protocol that has started, tap one of the **Pause** buttons on the **Status** screen protocol panels. When you tap either **Pause** button, protocols in both retorts stop running and the **Instrument paused** dialog box (→ Fig. 57) opens with a number of options:

- Abort all processing or just the protocol in one retort.
- Access a retort—for example to add more cassettes—and then resume the protocol running in it.
- Vent the paraffin baths so you can open them.

5 Running Protocol

When the system starts to count down (→ Fig. 57-1), options are enabled for selection. You have five minutes to select an option, after which processing automatically resumes.

Emergency stop and abort

After you have paused the instrument you can abort all protocols with the **Emergency stop** button (→ Fig. 57-2). Note that this does not shut down or remove power from the instrument (→ p. 53 – 4.6 Switching on and off).

Alternatively, abort the protocol run in the selected retort only with the appropriate **Abort** button. Any protocol running in the other retort will resume.

When processing stops, the instrument goes through the same routines it does at the end of a normal protocol run. It prompts you to drain the retort (if full), remove cassettes, and run a cleaning protocol. However, there will be an additional prompt during the recovery steps (with on-screen help to assist you) (→ p. 87 – 5.6.1 Recovering from an aborted run).



Note

- After aborting a protocol, you may wish to run a reprocessing protocol to recover your cassettes. In this case do not remove your cassettes or run a cleaning protocol when prompted to do so. Appropriate action after an aborted run can be found in (→ p. 87 – 5.6.1 Recovering from an aborted run).
- If the last reagent was a fixative, you can skip the cleaning protocol, as the residue will not prevent you from running a typical processing protocol. If you decide to run a cleaning protocol, set the first step to a cleaning ethanol (→ p. 82 – 5.5.2 Changing the starting step for a single run). Cleaning solvents are incompatible with fixatives.

Access retort

You can access retorts on a paused instrument (to, for example, add or retrieve specimen). If space permits, you can add cassettes to the baskets, and add one basket to one or both retorts if there was only one basket inside each retort. If you are adding baskets, you can enter their ID—either by scanning or by direct entry—before resuming the run.

If you wish to add extra cassettes or baskets, it is recommended that you drain the retort before opening it.



Warning

Add fixed samples to a running protocol.

Impaired samples.

- Take care when adding fixed samples to a running protocol. The additional fixative will contaminate the reagent used in the current step and this contamination will not be tracked by the reagent management system.

**Warning**

Add more samples during processing.

Impaired samples.

- The further a protocol has progressed before you add more samples, the more compromised is the processing quality for those samples. You only add samples during fixative steps or during the first dehydrant step.

To access a retort while the instrument is processing:

1. Pause the instrument by tapping one of the **Pause** buttons on the **Status** screen.
2. Tap the appropriate **Access retort** button in the **Instrument paused** dialog box.
3. Select to drain the retort or not in the **The retort is not empty** dialog box. Follow the prompt to wait if draining.
4. When the **Retort Baskets** dialog box opens, remove the baskets from the retort and add or retrieve cassettes, as required.
5. Return the baskets to the retort (scan or enter IDs if necessary) and tap **OK** in the **Retort Baskets** dialog box.
6. Tap **Resume All** in the **Instrument paused** dialog to resume the protocol.

5.6.1 Recovering from an aborted run

1. Gather information
 - A. Check the **Run Details** report (**Administration > Reports > Run Details**).
 - B. Check the event logs (**Administration > Event Logs**).
2. Decide
 - A. Based on the information in the report and the logs, should you continue to process tissue on the instrument?
 - B. If the instrument has failed, remove the tissue and then use the **Run Details** report to decide on the step to continue with on another instrument.
 - C. If the instrument is fine but a reagent is missing or its level is low, deal with the issue and then use the **Run Details** report to decide on the step to continue with.
3. Act: Based on your decision, either
 - A. remove the tissue from the instrument and call service, or
 - B. continue processing by loading a protocol and using the **Edit steps** function to select the appropriate starting step (→ p. 82 – 5.5.2 [Changing the starting step for a single run](#)).

5.7 Retort scheduling

The system allows you to run protocols simultaneously in both retorts. The automatic scheduling function attempts to assign reagent stations and start times so that there are no clashes. It may alter your requested end time by starting the protocol early or by delaying one or more steps (→ p. 88 – 5.7.1 [Delayed end times and initial fills](#)).

When a second protocol starts, the reagent stations assigned when the protocol was loaded may change. This occurs because the first protocol's reagent requirements always take precedence.

It is sometimes not possible to schedule a second protocol. This situation, and possible remedies, are discussed in ([→ p. 88 – 5.7.3 Unavailable reagents](#)). Also, protocols will sometimes fail if a reagent station unexpectedly becomes unavailable. See ([→ p. 88 – 5.7.3 Unavailable reagents](#)) for ways to avoid this situation.

5.7.1 Delayed end times and initial fills

Protocols do not need to start immediately and it is possible to set a required end time that necessitates a delay before the protocol begins. This delay can extend to many days. Also, when selecting the **ASAP** (As Soon As Possible) scheduling option, or if you have requested an end time that is not achievable, the instrument may be forced to delay the start of the protocol. During the protocol delay, the instrument will protect your cassettes by covering them with reagent. This process is called an initial fill.

During the initial fill, the retort is filled with the first scheduled reagent (usually a fixative) to protect the samples. Unless the reagent is paraffin, no heating or agitation occurs. If the initial step is paraffin (for reprocessing or paraffin-only protocols), the retort temperature will be set to paraffin standby, and the stirrer will be set to the first step's speed. Once the initial fill period is over, the protocol will run normally and will finish at the predicted end time.

We recommend that all protocols start with a fixative step (even if it is very short); thus a fixative is used for any initial fill. If there is no fixative step, an initial fill may leave your tissue covered with dehydrant for a long time, and this could cause the tissue to become hard and brittle.

5.7.2 Unavoidable reagent clashes

Unavoidable clashes occur when there are insufficient reagent stations available for both protocols to satisfy the reagent selection rules ([→ p. 91 – 6.1.2 Reagent selection method](#)). This mostly occurs when you are using type-based or station-based protocols, as they have limited station assignment flexibility.

Always ensure that there are sufficient stations of the first reagent group or type so that a station is available for an initial fill.

5.7.3 Unavailable reagents

Once a protocol starts, type-based protocols may reassign stations to recover from errors caused by unavailable reagents (for example, when a bottle is locked by a density meter). This reassignment may use reagents assigned to the other protocol.



Note

- Station-based protocols will fail if an assigned reagent becomes unavailable. Type-based protocols will fail if there is only one station with an assigned type and it becomes unavailable.

Some common causes of station unavailability, and ways to avoid them, are described below.

- The station contains insufficient reagent. Prior to each run, check that the reagent level in each station is sufficient for the current fill level. (Go to **Reagents > Stations** for the current level.)
- A bottle scheduled for use is removed from the reagent cabinet. For safety reasons you should not remove any bottle while a protocol is running. However, if you choose to do so, you must make sure the bottle you intend to remove is not scheduled for use in either retort.
- A paraffin station is not molten at the time it is required. Make sure there is adequate time for the paraffin to melt and that the correct paraffin station state is set ([→ p. 119 – 7.3.2 Setting reagent station properties](#)).
- A density meter has calculated a concentration and it does not match the concentration recorded for the reagent on the **Reagent Stations** screen (**Reagents > Stations**). The contents of the bottle will need to be changed or checked—by operators or supervisors—and the concentration updated by a supervisor. The concentration will be rechecked by the density meters.

6. Protocol Setup

6.1 Protocol overview

A protocol consists of series of steps that will be applied to tissue in a retort. In each step (with one exception) the retort is filled with reagent and held for a time under conditions controlled by the protocol. Each protocol step specifies:

- the reagent used
- the time the reagent is in the retort
- the temperature of the reagent
- the retort pressure: ambient, pressurized or vacuum, or cycling between pressurized and vacuum
- the retort stirrer On/Off
- the drip time, that is, the time allowed for reagent to drip from the cassettes and retort walls before the protocol begins the next step. Longer drip times reduce carryover.

The one step type that is an exception is the final dry step of a cleaning protocol, where no reagent is used.

There are five protocol types. A protocol's type sets limits on which reagents can be used and the order of their use.

Other protocol properties are the reagent selection method and a mandatory carryover value.

6.1.1 Protocol types

The Instrument uses five protocol types, each for a different processing function. The protocol types allow different reagent sequences and temperature ranges (→ p. 169 – 10.5 [Reagent compatibility tables](#)) (→ p. 169 – 10.4 [Protocol Step temperatures](#)). Once a protocol is created, you cannot change its type.

The protocol types are:

- **Standard** – conventional tissue-processing sequences using a clearer such as xylene. These protocols are suitable for normal processing requirements and can include defatting steps.
- **Xylene-free** – protocols with high-temperature paraffin steps and advanced processing techniques to process tissue without conventional clearing steps. These are suitable for normal processing requirements.
- **Cleaning** – protocols to clean the retorts and common reagent lines. Always run a cleaning protocol as soon as possible after paraffin has been in the retort. See [Cleaning Protocols](#) (→ p. 68 – 5.3 [Cleaning protocols](#)) for further information.
- **Standard Reprocessing** – to recover under-processed tissue on an instrument configured for standard processing. These protocols start with cleaning reagents before initiating a standard tissue-processing sequence.

- **Xylene-free Reprocessing** – to recover under-processed tissue on an instrument configured for xylene-free processing. These protocols start with cleaning reagents before initiating a xylene-free tissue processing sequence.

For the icons used for each protocol type, refer to ([→ p. 96 – 6.2.1 Protocol selection screen](#)).

Note the following points:

- Xylene-free reagent selection – xylene-free protocols use two sets of dehydrants rather than dehydrant followed by clearer, as used in standard protocols.
- Xylene-free baskets – always use baskets with springs for xylene-free protocols.
- Reprocessing carryover – during reprocessing protocols, there is significant reagent carry-over following the use of cleaning agents. After running a reprocessing protocol, you should replace the first three processing reagents that are used after the last cleaning reagent.

6.1.2 Reagent selection method

All protocols use one of two reagent-selection methods: type or station. Once a protocol is created, you cannot change its reagent-selection method.

A protocol's reagent-selection method determines the way the system selects reagent stations when the protocol is running. With the station selection method, you define exactly the station to use for each step, so the system makes no choices. For type selection, the system selects the best station from those available to it ([→ p. 91 – Station selection rules](#)). In summary:

- **Type selection** – the system selects from those stations with reagent of the type defined for the protocol step. Station reagent names (i.e. types) and concentration are used for selection. For example, you have two bottles with reagent types Ethanol 70% on the instrument. If the first dehydrant step in the protocol specifies Ethanol 70%, then the Ethanol 70% bottle with the lower concentration will be used.
- **Station selection** – the system uses the stations defined in the protocol. (Typically, you define the bottles in order: bottle 1 first, then bottle 2, 3, etc.). Stations are defined by number, so neither the name of the reagent in a station (its type) nor the reagent group are used for selection. Use the example above, if there are two Ethanol 70% bottles on the instrument and the first dehydrant step of the protocol specifies the first of the two bottles, that bottle will be used regardless of the concentration of reagent in the other bottle.

Station selection rules

The system uses the following rules to select stations for protocols with type-reagent selection. "Sequence", as used below, means a series of protocol steps using the same reagent type.

- The first step of a sequence uses the lowest concentration station available.
- The last step of a sequence uses the highest concentration station available.
- Intermediate steps in a sequence use the lowest concentration station that has not already been used.
- Where there is a single step for a particular reagent group or type, the highest concentration station is used.
- Stations that have exceeded their use thresholds (and are not locked) are not selected unless there is no other station available.

Reagent selection methods compared

When creating protocols, you should decide which method best suits your processing needs and reagent management strategy. Note that Xylene-free protocols use dehydrants for two different functions.

Type selection offers these benefits: optimal selection of reagents according to concentration, minimal reagent management, efficient reagent use, and minimal scheduling conflicts.

Station selection gives you total control over reagent selection. However, as reagents degrade, you may need to rearrange bottles between protocols if you want to ensure the most suitable reagents are used. This is a significant management burden and prone to error. Also, the station selection method does not allow the instrument any flexibility when scheduling protocols. For example, it will not be able to recover from a processing error caused by unexpected reagent unavailability.



Note

- When running station-selection protocols, always check the concentration of the assigned stations before starting a run, as the concentrations may not be correctly ordered if other protocols have been run.

Your decision about the reagent-selection method must be made in combination with decisions about how many, and which, reagent types you use, and the concentration thresholds to set for them. Note that all the pre-defined protocols in the system use type selection, but with recommended bottle configurations that have the minimal number of reagent types (→ p. 162 – 10.2.2 List of pre-defined protocols) (→ p. 166 – 10.3 Station configurations).

6.1.3 Pre-defined protocols

The system has 5 pre-defined protocols: Biopsy Xylene, Overnight Xylene, Biopsy Xylene-free, Overnight Xylene-free, and Quick Clean. Like all protocols, the pre-defined protocols can be accessed by selecting **Administration > Protocols**.

The pre-defined protocols are designed for use with the bottle configurations (→ p. 166 – 10.3 Station configurations). Leica Biosystems has extensively tested the protocols and found they give excellent results (in combination with proper reagent management and instrument maintenance). However, users should validate all protocols, including the pre-defined protocols, for use in their laboratories, as different conditions could give different outcomes.

Pre-defined protocols can be copied and the copies then be edited to suit your purposes. They will need to be renamed before they can be edited (→ p. 99 – 6.2.3 Creating new protocols).

6.1.4 Protocol validation

Supervisors creating or editing protocols (or copying pre-defined protocols) can validate them in the software. This serves as a sign that the protocols have passed the laboratory’s validation tests and can be used for regular clinical processing. Supervisors can also make valid protocols invalid.

Protocols that have been marked as valid can be run by operator-level users, while invalid protocols cannot. Invalid protocols can be run by supervisors.

Icons for validated protocols have a check (→ Fig. 58-1) in a green circle, while the icons for invalid protocols have a cross (→ Fig. 58-2) in a red circle.



Fig. 58

Set the protocol validity status on the **Edit protocol** screen by tapping **Validate protocol** (to validate an invalidated protocol) or **Invalidate protocol** (to invalidate a validated protocol).

6.1.5 Carryover setting

When a reagent drains out of a retort, a certain amount of the reagent remains in the retort and mixes with the next reagent in the protocol. The carryover setting is an estimate of the amount of a reagent that is carried over from one protocol step to the next. The reagent management system takes the carryover setting into consideration when determining reagent concentrations.

The residual reagent carried over can come from:

- Reagent retained on retort walls and baskets
- Reagent on and infiltrated into tissue
- Reagent on and infiltrated into small-tissue carriers (e.g. biopsy pads, biopsy cassettes, wraps, etc.).

The reagent management system automatically calculates the carryover on retort walls and baskets, taking into account the drip time.

The carryover due to cassettes and tissue is calculated using the number of cassettes entered by users at the start of each run. The amount of carryover on a standard cassette is used in the calculation. Drip time is also included.

The reagent management system calculates carryover from small-tissue carriers using the protocol carryover value you set.

Carryover values are on a scale from 0 to 100:

- A setting of 0 indicates that there is no carryover due to small-tissue carriers like biopsy pads, that is, the run has only standard cassettes with no small-tissue carriers.
- A setting of 100 indicates there is carryover equivalent to having all the tissues in a run using biopsy pads. (Biopsy pads have the maximum carryover of all small-tissue carriers.)

Because biopsy pads can have up to 10 times the carryover of standard cassettes, it is important to set a truly representative carryover value in your protocols (as it is to accurately enter the number of cassettes in each run). If you set too high a carryover value, the system calculates an excessive degradation of reagents, which will require you to replace them sooner than necessary. With too low a setting, the system will consider that reagents are purer than they are. Thus, you will use reagents beyond their optimal effectiveness, resulting in poor processing quality.

Only supervisors can set carryover values. The default value is set on the **Processing settings** screen (**Settings > Processing settings**). The carryover value for a specific protocol can be changed on the **Edit Protocol** screen (**Administration > Protocols > Edit**). Tap the **Carryover** button and enter a number between 0 (no carryover from small-tissue carriers) and 100 (maximum carryover from small-tissue carriers).

How to calculate carryover values

Carryover is dependent on the types of cassettes and other small-tissue carriers used: biopsy pads, paper or tissue inserts, mini cassettes, biopsy cassettes, etc. It also depends on the proportion of these in each run.

The carryover setting is a setting for a protocol, not for a specific run, so it must be set to the average carryover value for runs that use that protocol.

The following table shows the carryover values that should be used for a range of cassettes and other tissue carriers provided by Leica Biosystems. The values in the table apply when all the tissue in the run uses the respective cassette or carrier type.

Table 6.1: Carryover values for a range of tissue carriers provided by Leica Biosystems

Leica Biosystems products	Generic description of tissue carrier	Carryover value if 100% of tissue uses carrier
Surgipath ActivFlo Routine I	Standard cassette	0
Surgipath Biopsy Pads in Surgipath ActivFlo Routine I	Biopsy pad in standard cassette	100

Leica Biosystems products	Generic description of tissue carrier	Carryover value if 100% of tissue uses carrier
ActivFlo Mini Cassette in Surgipath ActivFlo Routine I	Mini cassette in standard cassette	50
Surgipath Biopsy Wraps in Surgipath ActivFlo Routine I	Biopsy wrap in standard cassette	20
Surgipath IP ActivFlo Biopsy I McCormick MC-605	Biopsy cassettes with >1 mm pore size	0

Sample calculation

Suppose that the average run of a protocol uses the following proportions of tissue carriers:

- Surgipath ActivFlo Routine I: 40%
- Surgipath Biopsy Wraps in Surgipath ActivFlo Routine I: 60%

Multiply the proportion of each carrier by its value in the table above to calculate the additional carryover value for that carrier:

- Surgipath ActivFlo Routine I: $40\% \times 0 = 0$
- Surgipath Biopsy Wraps in Surgipath ActivFlo Routine I: $60\% \times 20 = 12$

Add the resulting values:

$$0 + 12 = 12$$

Enter a carryover value of 12 for the protocol.

Other products

For small-tissue carriers other than those listed in Table 6.1 (→ p. 94 – Table 6.1: Carryover values for a range of tissue carriers provided by Leica Biosystems), we recommend you start with a carryover setting of 50. Use your own observations of tissue and reagent quality to refine this value. Tissue shrinkage in the block and excess solvent in the paraffin bath could indicate that you have too low a carryover setting.



Warning

Inappropriate carryover settings for the sample types being processed can cause sample damage!

To ensure correct carryover settings:

- For carryover settings, please refer to Chapter 6.1.5 'Carryover setting'.
- The pre-defined and customized protocols (carryover value included) must be validated by the laboratory according to their standard operating procedure.



Note

- It is the responsibility of users to validate the carryover settings in their protocols. Contact your technical support representative if you require assistance applying suitable carryover settings.

6.1.6 Protocol files

Protocols can be exported via USB in a database file with a .db extension. You can backup this file. You can also send the protocols to your service representative for troubleshooting. Backed-up protocol file can be imported into the HistoCore PEGASUS Plus.

See File transfer (→ p. 140 – Export files) for instructions on how to export and import protocol files.

6.2 Creating, editing, and viewing protocols

Supervisors can create and edit protocols. This is done from the **Protocol selection** screen. Operators cannot create or edit protocols but can view protocol details from the **Protocol selection** screen.

6.2.1 Protocol selection screen

Tap **Administration > Protocols** to open the **Protocol selection** screen. From here you can access all protocol configuration options.

Protocol icons

Each protocol is represented on the **Protocol selection** screen by a selectable icon. Each icon shows the following protocol details:

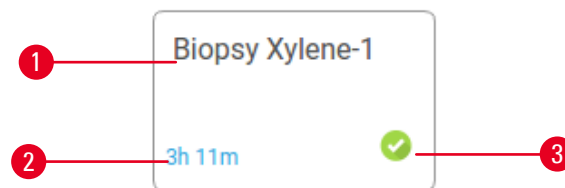

Fig. 59

1. Protocol name
2. Protocol duration
3. Validation status

6.2.2 Editing protocols

Only supervisors can edit protocols. To edit a protocol, open the **Protocol selection** screen (**Administration > Protocols**), select the protocol and then tap **Edit**. The **Edit Protocol** screen appears.

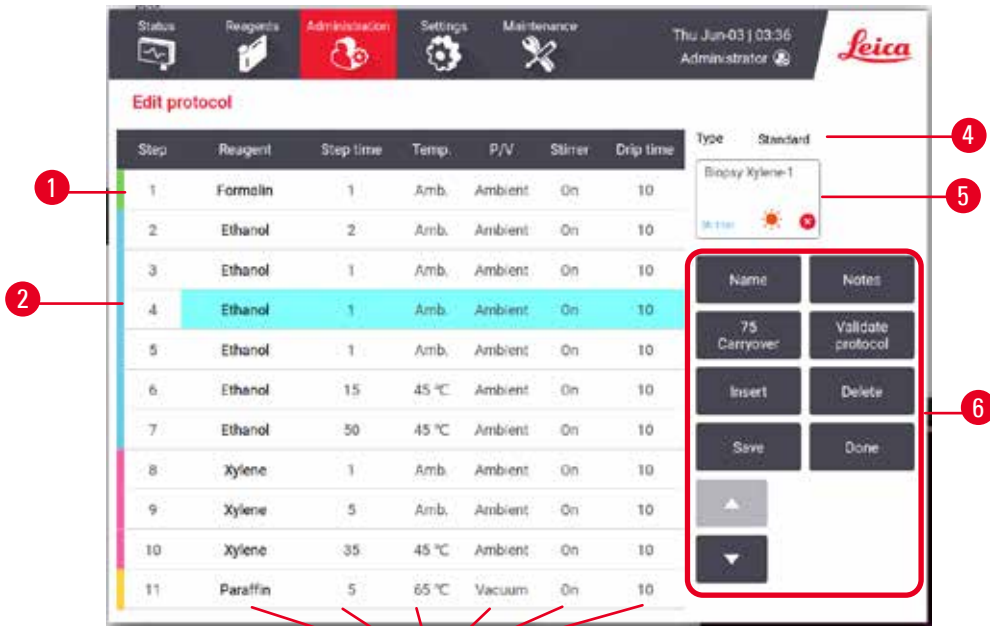

Fig. 60

1. Each row represents a protocol step
2. Tap a step number to select the step
3. Cells in the step table show the settings for each step. Tap a cell to open a dialog box to change the setting.
4. Protocol type (cannot change)
5. Protocol icon: updates as a protocol is edited
6. Protocol configuration buttons

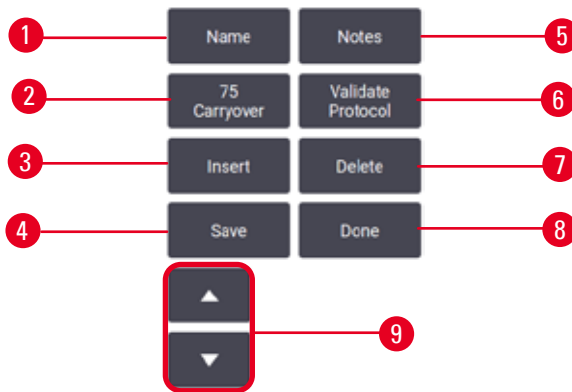

Fig. 61

1. **Name:** change the protocol name
2. **Carryover:** set the carryover value
3. **Insert:** insert a step before the selected step
4. **Save:** save changes made to the protocol
5. **Notes:** enter a description or other notes for the protocol
6. **Validate/Invalidate protocol:** set the protocol as valid or invalid
7. **Delete:** remove the currently selected step from the protocol
8. **Done:** confirm changes made to the protocol and return to the **Protocol selection** screen
9. Go to the previous/next row

6 Protocol Setup

Steps can be added and removed, and step details (such as the Step time, temperature, etc.) can be changed. The protocol's name, notes, carryover setting and validation status can also be changed. However, you cannot change the protocol type or reagent selection method, nor can you remove the dry step from a cleaning protocol.

By default, a changed protocol is not a valid protocol. Users will need to validate it before clinical use. Once validated, a supervisor can return to the **Edit protocol** screen and tap the **Validate protocol** button. The protocol then becomes available to operators.

Selecting reagents

You can change a reagent by tapping on the current reagent in the **Reagent** column in the **Edit protocol** screen. The dialog box that appears depends on the reagent selection method.

Only reagents that are compatible with the preceding protocol step (for the protocol's type) are shown. For station-based protocols, you can hide stations that have already been selected. If you choose an incompatible or hidden reagent, it is added to the protocol table with an asterisk to indicate that it is disallowed. You cannot load or run the protocol.

Type reagent selection

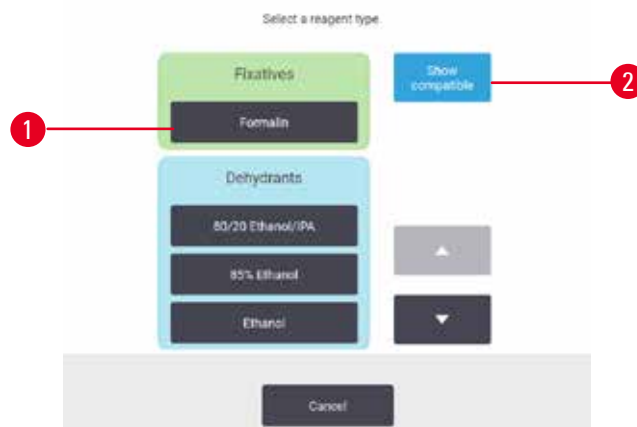

Fig. 62

1. Reagent type
2. **Show compatible/Show all**: show only compatible reagent groups/show all reagent groups

If the protocol is based on reagent types, the reagents configured for the instrument are grouped by type. You can select a specific type.

Station reagent selection



Fig. 63

1. **Show compatible/Show all:** show only compatible stations as available/show incompatible stations as available
2. **Hide used:** hide stations that have already been selected as unavailable

If the protocol is based on stations, you will see all the stations configured for the instrument. Bottles that are available for selection are drawn in 3D with caps and handles. Bottles that are not available, because they have already been used or are incompatible, are grayed out. Paraffin stations are similarly drawn as highlighted icons (available) or grayed out icons (unavailable). Select specific stations for your protocol.

Deleting a protocol

Only supervisors can delete a protocol.

To delete a protocol, select its icon on the **Protocol selection** screen and tap **Delete**.

Pre-defined protocols can not be deleted. Other protocols cannot be retrieved, unless you have copied them to an external device. You can then import the protocol using the file transfer functions.

6.2.3 Creating new protocols

Only supervisors can create new protocols.

You can create new protocols from scratch, or copy and modify an existing protocol (pre-defined or otherwise). Make sure you select the right protocol type and reagent selection method when you start (or copy a protocol of the right type and reagent selection method) because these settings cannot be changed after you have started to configure the new protocol.

**Warning**

User defined protocols are not validated.

Sample damage

- The pre-defined protocols and the customized protocols have to be validated by the user before running the protocol, i.e. tissue processing with patient tissue for diagnostics, according to the local or regional accreditation requirements.

Creating new protocols from scratch

1. Open the **Protocol selection** screen (**Administration > Protocols**) and tap **New**.
2. Select the protocol type (→ p. 90 – 6.1.1 Protocol types)
3. Enter a name for the protocol.
4. Choose a reagent selection method (→ p. 91 – 6.1.2 Reagent selection method). A series of dialog boxes will now guide you through creating the first step.
5. Tap the next row in the protocol table to add the second step. You are prompted to supply the reagent and step time. Other step properties (pressure, stirrer, etc.) are inherited from the previous step. Tap the appropriate cell to change any of these values.
 - » Use graded ethanol after the formalin step. Using 100% ethanol right after the formalin step will have the risk of salting-out. Cleaning protocols automatically have a final dry step. You cannot edit this step.
6. Add further steps as required.
7. Optionally tap the **Name** button to edit your protocol name.
8. Optionally tap the **Notes** button to add any information you want to keep with the protocol.
9. Tap the **Carryover** button and set a carryover value (→ p. 93 – 6.1.5 Carryover setting).
10. Tap the **Save** button to save the protocol.
11. Tap the **Done** button to finish.
12. The window appears warning you of any actions that are required or recommended before the protocol can be used (→ Fig. 64). One warning always listed is that the protocol is not validated for use. By default, a newly created protocol is not a valid protocol. Your laboratory will need to validate it before clinical use. Once validated, a supervisor can go to the **Edit Protocol** screen and tap the **Validate protocol** button. The protocol then becomes available to operators (provided that any other errors listed on the window have been attended to).



Fig. 64

- ✓ Your new protocol will now appear in the protocol selection list.

To create a new cleaning protocol, please see Cleaning protocols (→ p. 68 – 5.3 Cleaning protocols).

Copying protocols

Supervisors can copy any protocol displayed on the **Protocol selection** screen and create a new one based on it.

1. Tap **Administration > Protocols** and, on the **Protocol selection** screen, either:
 - A. select a protocol to copy and tap **Copy**, or
 - B. tap **New > Pre-defined** icon and then select the pre-defined protocol to copy.
2. Enter a new name for your protocol.
3. A warning appears informing you that the new protocol is not yet valid for use. Tap **OK** to close the warning. The **Edit protocol** screen opens with the details of the copied protocol.
4. Modify the protocol (→ p. 96 – 6.2.2 Editing protocols). You cannot edit the final dry step in cleaning protocols.
5. Tap the **Save** button to save the protocol.
6. Tap the **Done** button to finish.
7. The window (→ Fig. 64) appears warning you of any actions that are required or recommended before the protocol can be used. One warning always listed is that the protocol is not validated for use. By default, a newly created protocol is not a valid protocol. Your laboratory will need to validate it before clinical use. Once validated, a supervisor can go to the **Edit Protocol** screen and tap the **Validate protocol** button. The protocol then becomes available to operators (provided that any other errors listed on the window have been attended to).

- ✓ Your new protocol will now appear in the protocol selection list.

6.2.4 Viewing protocols

Operator-level users cannot create or edit protocols. However, they can view the details of a protocol (including step details, notes, and the date and time the protocol was last modified).

1. Tap **Administration > Protocols**.
2. Tap once on the protocol you want to view.
3. Tap **View**.

7. Reagent Setup

7.1 Overview

Using the right reagent at the right time, and at the right concentration, is of utmost importance for high-quality tissue processing. The system has an advanced reagent management system (RMS) that helps ensure consistently high-quality processing while giving you workflow flexibility.

7.1.1 Reagent groups, types, and stations

The system manages reagents by groups, types, and stations.

Groups

Groups specify reagent function. For example, the fixatives reagent group includes all reagents that can be used as a fixative.

There are 10 factory-defined groups. Each group has a color-code that used consistently in the software, on bottle labels and on caps. The table below lists the groups, functions, and colors.

Table 7.1: Reagent groups and colors

Group	Function	Color
Fixatives	Tissue preservative	Green
Dehydrants	Removes water from tissue	Blue
IPA	Removes water from tissue	Light purple
Defat	Removes fat deposits from tissue	Yellow
Post defat	The dehydrant used after a defatting step	Purple
Clearers	Clears the dehydrants from the tissue	Pink
Paraffin	The embedding medium	Orange
Processing water	Removes fixatives from tissue	Sky blue
Cleaning solvent	First cleaning reagent	Light pink
Cleaning ethanol	Second cleaning reagent	Light blue

A reagent is considered compatible in a protocol run based on its group ([→ p. 111 – 7.1.6 Reagent compatibility](#)).

Types

Reagent types are the specific reagents within each group, for example, formalin, xylene, Waxsol. As well as the chemical constituent, reagent-type definitions can include concentrations. For example, “70% Ethanol” and “80% Ethanol” are reagent types (and defined in this system).

Reagent types have the following properties:

- Unique name
- Default concentration: the concentration of the reagent when fresh.
- Purity thresholds: to ensure that you replace degraded reagent (→ p. 106 – 7.1.3 Thresholds).
- Temperature thresholds: used to ensure processing quality and safe usage of the reagent (→ p. 106 – 7.1.3 Thresholds).

The system includes a number of pre-defined reagent types. These are adequate for most laboratories. However, you can create your own reagent types if needed. Tap **Reagents > Reagent types** to define and edit reagent types (→ p. 112 – 7.2 Managing reagent types).



Note

- Reagent type names do not affect reagent concentration. For example, when assigning a reagent type called “Ethanol 70%” to a station, the initial concentration value would be the type’s default value (probably 70%) but you can set the initial concentration to anything between 0 and 100%.

Stations

The system has 21 reagent stations: the 17 reagent bottles and the 4 paraffin baths.

Each station has the following properties:

- The reagent type that the station contains
- The concentration of the reagent in the station, as calculated by the reagent management system
- The history of the station’s use, namely:
 - A. The number of cassettes processed with the reagent in the station
 - B. The number of runs (that is, cycles) processed with the reagent in the station
 - C. The number of days the reagent has been in the station
- The station’s state, namely:
 - A. **Dry**: the station has been completely drained leaving only a small amount of residue. It can be filled with any compatible reagent.
 - B. **Empty**: reagent has been removed from the station to fill a retort. Reagent in excess of the amount needed to fill the retort remains in the station.
 - C. **In use**: a reagent transfer is in progress or has been aborted.
 - D. **Full**: the station holds enough reagent to fill a retort.
 - E. **Not molten**: for paraffin chambers only, the state to set when adding solid paraffin (→ p. 128 – 7.4.5 Replacing paraffin).
- For paraffin baths only, the paraffin baths’ current temperature.

Go to **Reagents > Stations** to define reagent stations and to monitor their history and concentration (→ p. 117 – 7.3 Managing reagent stations).

7.1.2 Concentration management

The high-quality tissue processing delivered by the system is largely due to its accurate monitoring of the concentration of the reagents in each station.

Concentration in the system

Concentration is the proportion of a reagent that is of the group to which the reagent is assigned. The following examples illustrate how the concentration is determined.

- A dehydrant that is 80% ethanol (a dehydrant) and 20% water (not a dehydrant) has a concentration of 80%.
- A dehydrant that is 80% ethanol (a dehydrant) and 20% IPA (also a dehydrant) has a concentration of 100%.
- Absolute ethanol (100% dehydrant) contaminated by carryover from absolute IMS (100% dehydrant) has a concentration of 100%, as both the original reagent and the contaminant are dehydrants.
- A new xylene (100% clearer) contaminated by carryover from absolute ethanol (100% dehydrant) has a reduced concentration—typically around 94% after one cycle—as it will consist of 94% xylene (clearer) and 6% ethanol (not a clearer).

A reagent that is used early in a sequence of the same group will have rapid concentration decline, as most of the contamination it receives will be from the previous group. A reagent that is used late in a sequence will have a slower concentration decline, as most of the contamination it receives will be from the same group.

Managing concentrations

The software uses reagent concentrations to select stations when protocols are run (unless the protocol uses station-reagent selection). It selects the station with the lowest in-threshold concentration of a reagent group or type for the first step using that group or type, then stations of increasing concentration for following steps. It always uses the highest concentration reagent for the last step before changing to another reagent group or type. The software also uses concentration information (amongst other factors) to prompt you to change reagents that have exceeded purity thresholds.

It is very important for high-quality processing and efficient reagent use, that the concentration information the software uses is accurate. The software automatically tracks the concentration of the reagent in each station, updating values after each run. To do this effectively you must enter accurate information for it to work with. You should, for example, set realistic protocol carryover values and enter the correct number of cassettes in each run. You should also update the software accurately whenever you change reagents.

By default, the software assigns concentrations “by calculation”. This method uses the number of cassettes processed, the carryover setting, and the reagent groups involved to calculate the concentration in each station.

7 Reagent Setup

For consistently high-quality processing, always replace reagents as soon as you are prompted— with fresh reagent at the default concentration. If you remove a bottle from the instrument, always check that you enter the correct reagent information for the bottle when you return it. Supervisors can manually change station concentration values in the **Reagent > Stations** screen if they believe the value there is incorrect. Be sure that you independently verify the concentration if making such a change.

Automatic concentration checking

The system has two density meters, one for each retort. The meters measure the concentration of certain reagents—listed in Table 7.2 below—when they are first used in a processing run under either of the following conditions:

- The reagent has been replaced or
- A supervisor has changed the concentration recorded for that reagent.

If the concentration measured does not match the concentration value recorded for that bottle on the **Reagent Stations** screen, the bottle is locked (and a warning symbol is superimposed over its icon on the **Status** screen.). A locked bottle is skipped in any subsequent run (assuming, that is, that the run can continue without the locked bottle).



Note

- Only ethanol (including reagent-grade ethanol and IPA–ethanol mixtures), IPA, and xylene reagents will be checked by the density meters. Fixatives, cleaning reagents, and reagent substitutes (such as Histolene) are not checked. Table 7.2 lists the reagents that will be checked. All other reagents—including those you create yourself—will not be checked.

Table 7.2: List of reagents checked by the density meters

- | | | | |
|---------------|-----------------------|----------------|--------------------------|
| • 50% Ethanol | • 95% Ethanol | • 70% IMS | • Isopropanol |
| • 70% Ethanol | • Absolute Ethanol | • 80% IMS | • IPA |
| • 80% Ethanol | • 80/20 Ethanol / IPA | • 90% IMS | • 50/50 Ethanol / Xylene |
| • 85% Ethanol | • Ethanol | • 95% IMS | • Xylene |
| • 90% Ethanol | • 50% IMS | • Absolute IMS | |

7.1.3 Thresholds

Each reagent type has a number of thresholds. These are designed to ensure high processing quality and user safety. Supervisors can configure the thresholds by going to **Reagents > Reagent types**.

The default thresholds for the pre-defined reagent types should be adequate for most laboratories, but alternative settings may suit some laboratories better. Contact customer support for advice before changing threshold settings. Validate any threshold changes using the procedures that apply in your laboratory.

The thresholds fall into two categories:

- Purity thresholds: these set usage limits for reagents according to their purity
- Temperature thresholds: these set limits on the retort temperature.

Purity thresholds

The system uses purity thresholds to limit the use of a reagent as it becomes increasingly contaminated with reagent carried over from other groups.

When a threshold is approaching or exceeded, the software warns you that you need to replace the reagent. Under default settings, you are able to use a station with out-of-threshold reagent for one more run after such a warning. Following this the station is locked (that is, it cannot be used until fresh reagent is loaded).

Reagent purity is checked using one or more of the following four methods:

- Concentration of the reagent
- Number of cassettes processed with the reagent
- Number of processing runs the reagent has been used for
- Number of days the reagent has been loaded on the instrument.

By default, all these methods are available for you to configure for individual reagent types (done on the **Reagent types** screen). The **Reagent threshold check** section of the **Settings > Processing settings** screen shows the methods enabled for your system (→ Fig. 65).



Fig. 65

These checking-methods settings can only be changed by customer support representatives.

The checking methods are designed to monitor three types of purity threshold:

- reagent approaching change thresholds
- reagent change thresholds
- final reagent thresholds.

These are explained below.

A further check of concentration purity is made by the instrument's density meters. This is explained in (→ p. 106 – [Automatic concentration checking](#)).

Reagent approaching change thresholds

Stations with a reagent that is approaching its change threshold are shown with a warning symbol on the **Status** screen. If you tap the warning symbol, a message specific to that bottle appears above the bottle, warning you to prepare the reagent in advance.

Reagent change thresholds

Stations with a reagent that has exceeded its change threshold are shown with a hatched icon on the **Status** screen.

The system does not use out-of-change-threshold stations unless no other stations are available. If no other stations are available, out-of-threshold stations will be used for one run before being locked. Locked stations cannot be used at all until the reagent is replaced. The system will not allow you to load protocols that require a locked station.

Final reagent thresholds

Final reagent thresholds set limits on the purity of the reagent that will immediately precede a change to another reagent group (or type, for protocols configured by type) in a protocol run.

Final reagent thresholds are set higher than change thresholds. This ensures minimum contamination from the preceding reagent group to the subsequent reagent group.

When a reagent type or group has exceeded its final reagent threshold (that is, no bottle within that type or group is at or above the final reagent threshold) a warning symbol in an orange diamond appears on the least pure bottle in that type or group. In addition, a message appears above that bottle.

After closing the message, you can redisplay it by tapping the warning symbol on the icon of the bottle.

When you start the next run, a message appears informing you that this is the last run possible without changing the reagent that is below its final threshold:

You can tap **OK** to proceed with the run. A warning symbol in a red triangle appears on the icon of the bottle on the **Status** screen.

If you tap the warning symbol, a message specific to that bottle appears above the bottle:

If you try to run another protocol that uses that reagent type, a message appears informing you that no further runs are possible until the reagent is changed.

Occasionally you might see a hatched bottle with a warning symbol in an orange diamond. This occurs when both final and change thresholds have been reached, so the bottle needing to be changed is both the least pure (final change threshold) and below the reagent change threshold.

Note: When you are warned that the reagent has exceeded the final threshold, replace the least pure bottle of the reagent type concerned. The bottle that exceeded the final reagent threshold, triggering the warning, will still have reagent with a relatively high concentration. It will still be acceptable for steps in the protocol sequence before the final step, so it is inefficient to replace it.

Temperature thresholds

There are three temperature thresholds for each reagent type:

- **Ambient** – the highest allowable temperature for the reagent in the retort at ambient (and high) pressure (based on the reagent's boiling point)
- **Vacuum** – the highest allowable temperature for the reagent in the retort when the retort is evacuated (based on the reagent's boiling point)
- **Safe** – the highest temperature at which it is safe to open a retort containing the reagent.

You will not be able to create protocols that put reagents in conditions that exceed their ambient or vacuum temperature thresholds. Further, the software warns you if you are required to open a retort and the retort contains reagent above its safe temperature threshold.



Warning

Wrongly set up reagent temperature threshold over its boiling point.

People injury/Sample damage/Environment contamination due to excessive fumes generated during processing.

- Take extreme care when deciding to change a reagent temperature threshold. Raised thresholds can lead to reagents boiling. Boiling reagents will release large quantities of fumes that may overload the internal active carbon filter or (if fitted) the external exhaust system. Boiling reagents are also likely to lead to excessive pressures within the instrument, increased reagent contamination and reagent spills. Reagent boiling points are lower when in a retort operating with a vacuum or with pressure/vacuum cycling.
- Never run the instrument without the active carbon filter or an external exhaust system. Even if the instrument is connected to an external exhaust device, the active carbon filter provided must remain in use.

7.1.4 Recommended reagents



Warning

Using reagents other than the recommended reagents

People injury - Fire or explosion may be caused by some toxic/flammable reagents.

Delayed diagnosis - Components of the instrument may be damaged by corrosive reagents.

- Use reagents suggested below with the instrument only.
- Do not use fixatives containing picric acid as picric acid is explosive when dry.
- Do not use reagents containing corrosive chemicals such as mercuric salts, picric acid, nitric acid and hydrochloric acid.
- Do not use acetone or other ketones. These damage the instrument's valves.

While each laboratory is responsible for its choice of reagents and paraffin, using reagents other than those recommended for this system can result in poor processing or compromise instrument reliability. Compliance with the following guidelines will ensure superior tissue processing.

The use of alternative reagents must be validated by your laboratory according to local or regional accreditation requirements.

Adequate fixation of tissue samples is required for optimum results. This should be achieved prior to placing the samples in the system or incorporated into the fixative steps of the protocol.

The following reagents have been validated for use with the system.

Fixatives

- 10% Formalin (buffered and unbuffered)
- Formal ethanol (70% ethanol and 30% formalin)

Dehydration

- 100 % ethanol
- Reagent grade ethanol recommended for Histological Use
- Ethanol diluted with water (deionized or distilled)
- 99 % ethanol (denatured)
- 99 % isopropanol (also used as intermedium)
- Isopropanol diluted with water
- < 50 % methanol

Clearing

- Aliphatic hydrocarbons (recommended for Histological Use)
- Isopropanol
- D-Limonene (recommended for Histological use)
- ParaLast™
- Sub-X
- Toluene
- Xylene

Infiltration

- Paraffin pellets or molten paraffin for Histological Use at the melting point of 56°C-58°C
- Surgipath infiltrating paraffines
- Surgipath high melting point paraffin at 60°C

Cleaning reagents

- Ethanol
- Reagent grade ethanol for Histological Use
- Reagent grade ethanol for histological Use
- Isopropanol
- Limonene
- SubX
- Toluene
- Xylene
- Waxsol
- Water (distilled and deionized)

7.1.5 Non-recommended reagents

The following reagents are not recommended for use with the system. Their use may cause instrument or tissue damage.

- Acetone
- Chloroform
- Fixatives containing Picric acid
- Histology paraffins containing dimethyl sulfoxide (DMSO), such as Paraplast Plus®
- Zinc Chloride

7.1.6 Reagent compatibility

Tissue processing requires the use of incompatible reagents. The software ensures that only compatible reagents are allowed to mix. Reagent mixing usually occurs when a reagent enters a retort with an Empty state (that is, it contains residual amounts of the previous reagent). This may happen as part of a protocol, during manual operations or during remote and fill/drain procedures.

You cannot run a protocol if the first reagent is incompatible with the retort residue. You can, however, load a protocol with an incompatible first step and then edit it so that the first reagent used is compatible with the retort residue (→ p. 82 – 5.5.2 [Changing the starting step for a single run](#)).

The software will also prevent you from mixing incompatible reagents during remote fill/drain procedures.

Reagent compatibility varies depending on the action or protocol being undertaken. Use the reagent tables (→ p. 169 – 10.5 [Reagent compatibility tables](#)) to check reagent compatibility before creating protocols, conducting manual operations, or starting remote fill/drain procedures.

7.2 Managing reagent types

The software uses two lists of reagent types: an active list (being the reagents you use) and a dormant list (being all the other reagent types configured in the system). Supervisors can edit the default concentrations, the purity thresholds, and temperature thresholds for active reagents ([→ p. 106 – 7.1.3 Thresholds](#)). They can also move reagents between the active list and dormant list, and create new reagent types. Operators can only view the active list.

7.2.1 Pre-defined reagents

A number of reagent types are pre-defined in the system. You can edit the properties of these reagent types, but they cannot be deleted. There is no requirement to use the pre-defined types; however, you can leave them on the dormant list.

If you change the properties of a pre-defined reagent type, you cannot use the software to automatically return it to its original values.

If you change the name of pre-defined ethanol (e.g. ethanol) or clearing agent (e.g. xylene), its concentration on first use will not be checked by the density meters.

7.2.2 Editing active reagent types

Use the **Reagent types** screen (**Reagents > Reagent types**) to view and edit the active reagent types list. You also access other reagent type management options from this screen.

When you open the screen, you see the list of active reagent types. These reagent types are available to set for reagent stations. There are two views of the active list: one each for purity and temperature thresholds. (Both views show default concentrations.) Change views with the **Change thresholds** ([→ Fig. 66](#)), **Final thresholds** ([→ Fig. 67](#)), and **Temperature thresholds** ([→ Fig. 68](#)) buttons.



Fig. 66

1. Selected reagent type
2. List of active reagent types
3. Density Meter check
4. Defaults and concentrations
5. Reagent change thresholds
6. Change thresholds button
7. Final thresholds button
8. Temperature thresholds button
9. Add reagent button: bring dormant reagent onto the active list
10. Remove reagent button: move the selected reagent from the active to the dormant list

Not all reagents are checked by the density meters. If there is Yes (→ Fig. 66-3) in the DM column for a reagent, it will be checked by the density meters.

7 Reagent Setup

Type	DM	Conc.	Conc.	Cassettes	Cycles	Days
Formalin	No	100.00%	N/A	N/A	N/A	N/A
Formal Saline	No	100.00%	N/A	N/A	N/A	N/A
Histochoice	No	100.00%	N/A	N/A	N/A	N/A
NBF	No	100.00%	N/A	N/A	N/A	N/A
Prefer	No	100.00%	N/A	N/A	N/A	N/A
Zinc Formalin	No	100.00%	N/A	N/A	N/A	N/A
50% Ethanol	Yes	50.00%	N/A	N/A	N/A	N/A
50% IMS	Yes	50.00%	N/A	N/A	N/A	N/A
70% Ethanol	Yes	70.00%	N/A	N/A	N/A	N/A
80% Ethanol	Yes	80.00%	N/A	N/A	N/A	N/A

Fig. 67

1. Selected reagent type
2. List of active reagent types
3. Density Meter check
4. Defaults and concentrations
5. Reagent final thresholds

Type	DM	Conc.	Ambient	Vacuum	Safe
Formalin	No	100.00%	60 °C	60 °C	45 °C
Formal Saline	No	100.00%	55 °C	55 °C	45 °C
Histochoice	No	100.00%	55 °C	55 °C	45 °C
NBF	No	100.00%	55 °C	55 °C	45 °C
Prefer	No	100.00%	55 °C	55 °C	45 °C
Zinc Formalin	No	100.00%	55 °C	55 °C	45 °C
50% Ethanol	Yes	50.00%	92 °C	63 °C	45 °C
50% IMS	Yes	50.00%	92 °C	63 °C	45 °C
70% Ethanol	Yes	70.00%	88 °C	59 °C	45 °C
80% Ethanol	Yes	80.00%	85 °C	57 °C	45 °C

Fig. 68

1. Selected reagent type
2. List of active reagent types
3. Density Meter check
4. Defaults and concentrations
5. Reagent temperature thresholds

Supervisors can edit the default concentration, change thresholds, final thresholds, and temperature thresholds for all active reagent types.

You edit a type's attributes by tapping the appropriate table cell and then entering the required value using the on-screen keyboard. The attributes update immediately and are applied to all reagent stations and protocols that use the reagent type. The changes will not affect running protocols.

**Note**

- Lowering temperature thresholds may make protocol steps invalid. You must lower the step temperature to comply with the new reagent threshold before you can load or run the protocol.

Leica Biosystems does not recommend that you lower reagent concentration thresholds. Raising concentration thresholds can help to correct poor quality processing due to impure reagents.

If you no longer use a reagent in the active list, you can move it to the dormant list, thus keeping the active list as small and easy to manage as possible. Select the reagent type by tapping its name and then tap **Remove reagent**.

7.2.3 Adding, hiding, and deleting reagents

To add, hide or delete reagents, go to **Reagents > Reagent types**. The **Reagent types** screen appears (→ Fig. 68).

To add a reagent

You can make a dormant reagent active and create a new reagent (that is, add a reagent that is not currently on the active list or dormant list of reagents).

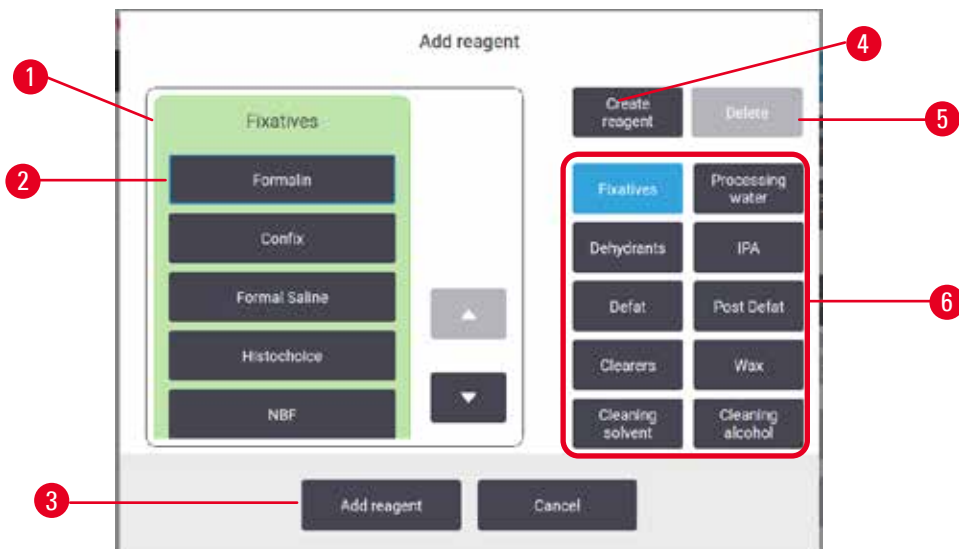

Fig. 69

1. Complete list of reagent types filtered by reagent group (with buttons at right)
2. Selected reagent type: tap button to select
3. **Add reagent**: transfer the selected reagent type from the dormant to the active list
4. **Create reagent**: create a new reagent to add to the dormant list
5. **Delete**: Delete the selected reagent type (user defined protocols only)
6. Reagent group filters: tap to show just the reagent types in the selected groups

1. Tap **Add reagent**. A dialog box (→ Fig. 69) listing all reagent types, ordered by the reagent group, appears.
2. To add a dormant reagent to the active list:
 - A. Tap the button (→ Fig. 69-6) at the right of the screen that corresponds to the reagent's group (Fixatives, Dehydrants, etc.).
 - B. Select the reagent in the list that appears at the left of the screen. (You may need to scroll down to find it.)
 - C. Tap **Add reagent** (→ Fig. 69-3).

✓ The **Reagent types** screen re-appears. The reagent you selected is now listed.

3. To add a new reagent type:
 - A. Tap **Create reagent** (→ Fig. 69-4).
 - B. Choose the group to which the new reagent belongs.
 - C. Enter a unique name for the reagent and tap **Enter**.

✓ The newly created reagent type is added to the list of dormant reagents.

- D. If you want to make a new reagent active, repeat from step 2 above; otherwise, tap **Cancel**. You are returned to the **Reagent types** screen.

To hide or delete a reagent

You can hide an active reagent by moving it to the dormant list. You can also delete a reagent. A deleted reagent no longer appears on either the active or the dormant list. (Only user-defined reagents can be deleted.)

1. To hide a reagent:
 - A. Select it on the **Reagent types** screen.
 - B. Tap **Remove reagent**.
 - C. Tap **OK** on the confirmation message.

2. To delete a reagent:
 - A. Tap **Add reagent**. A dialog box listing all reagent types, ordered by the reagent group, appears (→ Fig. 69).
 - B. Tap the button (→ Fig. 69-6) at the right of the screen that corresponds to the reagent's group (Fixatives, Dehydrants, etc.).
 - C. Select the reagent in the list that appears at the left of the screen. (You may need to scroll down to find it.)
 - D. Tap **Delete** (→ Fig. 69-5). If the **Delete** button is disabled, the reagent is pre-defined and cannot be deleted.
 - E. Tap **OK** on the confirmation message.
 - F. Tap **Cancel** to return to the **Reagent types** screen.

7.3 Managing reagent stations

The system has 21 stations: 17 reagent bottles and 4 paraffin baths.

You must set the stations in the software to the reagent types loaded on the instrument. Once this is done, the system tracks each station's history (the number of runs and cassettes processed and number of days loaded on the instrument), current concentration, and, for paraffin chambers, the current temperature. See (→ p. 103 – 7.1.1 [Reagent groups, types, and stations](#)) for further details.

Supervisors can set the reagent type for each station. They can also change concentration values if they know that actual concentrations are different from those recorded in the system. Both supervisors and operators can change station states if required. History details can only be viewed.

For the safe operation, it is essential that there are bottles loaded in place in the reagent cabinet. If you do not wish to use a particular station, set its state to **Dry** and, for non-paraffin stations, insert an empty bottle into the station's reagent cabinet location.

The choice of which reagent types to load on the instrument, and how many bottles of each, is an important decision you must make. It will depend on the protocols you run. See Station Configurations (→ p. 166 – 10.3 [Station configurations](#)) for configurations suitable for the default protocols.

7.3.1 Reagent stations screen

To set up and manage reagent stations, and view a station's history, go to **Reagents > Stations**. The **Reagent Stations** screen appears. This screen offers two views: one of the 17 reagent bottles (→ Fig. 70) and one of the four paraffin chambers (→ Fig. 71). Switch between views by tapping **Reagent bottles** or **Paraffin chambers**.

Station	Type	Conc.	Cassettes	Cycles	Days	State	Lot Number
1	Formalin	88.0%	450	3	4	Full	
2	Formalin	95.0%	150	1	4	Full	
3	70% Ethanol	100.0%	0	0	0	Full	
4	90% Ethanol	100.0%	0	0	0	Full	
5	Ethanol	100.0%	0	0	0	Full	
6	Ethanol	100.0%	0	0	0	Full	
7	Ethanol	100.0%	0	0	0	Full	
8	Ethanol	100.0%	0	0	0	Full	
9	Ethanol	100.0%	0	0	0	Full	

Fig. 70

1. **Reagent bottles** button
2. **Type**: reagent type in the station. Tap cell to change.
3. **Station**: station number with reagent group color code
4. Hatched cell indicates change threshold exceeded. Out-of-threshold concentration value is shown in red.
5. Selected station: tap in **Station** cell to select
6. **Conc.**: current concentration of the reagent in the station. Tap cell to change.
7. **Since changed**: the use history of each station – view only
8. **Lot Number**: Reagent Lot number details.
9. **State**: the current state of the station. Tap cell to change.

The screenshot shows the 'REAGENT STATIONS' screen with two tabs: 'Reagent bottles' and 'Wax chambers'. Below the tabs is a 'Since changed' section. The main table has columns: Station, Type, Conc., Cassette, Cycles, Days, Temp., State, and Lot Number. Station W2 is highlighted in cyan. A red box highlights the 'Cassette', 'Cycles', and 'Days' columns for all stations. Red callouts 1-9 point to: 1. 'Paraffin chambers' button; 2. 'Type' cell; 3. 'Station' cell; 4. Selected station; 5. 'Conc.' cell; 6. 'Since changed' section; 7. 'Lot Number' cell; 8. 'State' cell; 9. 'Temp.' cell.

Station	Type	Conc.	Cassettes	Cycles	Days	Temp.	State	Lot Number
W1	Paraffin	100.00%	0	0	342	65 °C	Full	
W2	Paraffin	100.00%	0	0	342	65 °C	Full	
W3	Paraffin	100.00%	0	0	342	65 °C	Full	
W4	Paraffin	100.00%	0	0	342	65 °C	Full	

Fig. 71

1. **Paraffin chambers** button
2. **Type:** reagent type in the station. Tap cell to change.
3. **Station:** station number with reagent group color code. Hatched cell indicates change threshold exceeded. Out-of-threshold concentration value shown in red.
4. Selected station: tap in Station cell to select
5. **Conc.:** current concentration of reagent in the station. Tap cell to change.
6. **Since changed:** the use history of each station – view only
7. **Lot Number:** Reagent Lot number details.
8. **State:** current state of station. Tap cell to change.
9. **Temp.:** current temperature in the paraffin chamber

7.3.2 Setting reagent station properties

Assigning new reagents to stations

- ⓘ You must be a supervisor to do this task, and there must not be a protocol running or loaded in either retort. Altering reagent station configurations while protocols are running may cause aborted protocols.

If you change the type of reagent loaded in a station you must change the reagent type assigned to the station in the software.

1. Remove the bottle with the reagent type (or drain the paraffin chamber) you are replacing.
2. Go to **Reagent > Stations** and tap in the station's **Type** cell. The **Type** dialog screen appears. (→ Fig. 72).



Fig. 72

3. Select the new reagent type from the list. The dialog box shows all the currently active reagent types. If the reagent is not listed, it may be on the dormant reagents list. See (→ p. 115 – 7.2.3 [Adding, hiding, and deleting reagents](#)) for instructions on how to activate a dormant reagent or add a new reagent.
4. When asked if you want to reset the properties of the selected station, tap **Yes**. This sets the history counters to zero and the station concentration to the default for the new reagent type.
5. Clean the bottle if necessary and fill with fresh reagent of the new type. Load the bottle back onto the instrument. (Alternatively, fill the paraffin chamber.)
6. For a bottle:
 - A. Pull out the bottle, replace the reagent, and load it back into the reagent cabinet. The **Replace the reagent bottle** screen appears.
 - B. Select the icon of the related bottle, and tap the **Changed** button.
 - C. Enter the reagent concentration.
 - D. Optionally enter the expiry date and lot number details.
7. For a paraffin chamber: Tap **State** cell and set the station state to **Full** on the **Reagent Stations** screen.

When you change the reagent type for a station, you are always prompted to reset the station's concentration and history. If you select **No** you will retain the previous reagent's concentration and history. Use this option only if you are correcting a previous error in the identification of the reagent in the station and are not actually changing the station's contents.



Warning

Wrong definition of reagents

Sample damage caused by reagents mismatch between GUI definitions and bottle labels.

- Always update station details correctly.
- Always check the definition of stations at/before the protocols start.
- Never update the details without replacing the reagent.

Changing reagent concentration

A supervisor can set a station's calculated concentration value. Tap the station's **Conc.** cell. Enter the new concentration using the on-screen keyboard.

If a change is made to a reagent listed in the table (→ p. 106 – [Automatic concentration checking](#)), the concentration of that reagent will be checked by the density meters when it is next used in a protocol run.



Warning

Incorrect setup of the concentrations

Sample damage or reduction in tissue processing quality

- Do not alter the concentration of a used reagent unless you are able to verify the actual concentration.

Setting station states

All users can change station states. Allowable states are **Full**, **Empty**, **In use**, and **Dry**.

You should not normally need to do this for reagent bottles. You update the bottle states when you remove and replace bottles, and then the software tracks the state automatically. Change bottle station states only if the wrong state is displayed or you want to make a full bottle unavailable for use (by setting it to **In use** or **Empty**).

For paraffin chambers, you must change the station state as a normal part of paraffin replacement.

To change a station state:

1. Go to **Reagents > Stations**.
2. Tap the station's **State** cell.
3. Tap the appropriate icon on the dialog that appears (→ Fig. 73).



Fig. 73

**Warning**

Wrong definition of reagents

Sample damage caused by reagents mismatch between GUI definitions and bottle labels.

- Always update station details correctly.
- Always check the definition of stations at/before the protocols start.
- Never update the details without replacing the reagent.

7.4 Replacing reagents

When the system alerts you that a reagent should be changed, you should do so as soon as possible.

There are two ways to replace reagent in bottles:

- **Remote fill/drain** – using commands on the **Remote fill/drain** screen, pump the old reagent out and new reagent in. You don't need to remove the bottle from the reagent cabinet.
- **Manually** – remove the bottle from the reagent cabinet, drain and refill it, and then replace it in the cabinet.

For paraffin, you must drain the paraffin baths using the **Remote fill/drain** screen, fill the paraffin baths manually, and then update the software.

7.4.1 Remote fill/drain screen

Use the **Remote fill/drain** screen (**Reagents > Remote fill/drain**), to fill and drain reagent bottles without removing them from the instrument. You use the same screen to drain the paraffin chambers. In a single operation, you can drain or fill a single station, or drain or fill a group of compatible stations. You can also fill and drain retorts from this screen. This enables you to recover from partially completed drain or fill operations.

The functions on the **Remote fill/drain** screen (→ Fig. 74) are available to all users: operators and supervisors.



Fig. 74

1. Fill to/Drain from bottles, Drain to waste, or Fill/Drain retort: start fill or drain when appropriate station, remote source, and retort are selected
2. Abort: stop the drain or fill
3. Waste paraffin: select with a paraffin chamber to drain the chamber
4. Remote: select with a retort and bottle to fill or drain the bottle
5. Retort A: scheduled fill/drain operations for retort A
6. Retort B: scheduled fill/drain operations for retort B
7. Paraffin System: scheduled drain operations for the paraffin chambers

7.4.2 Remote fill/drain connections

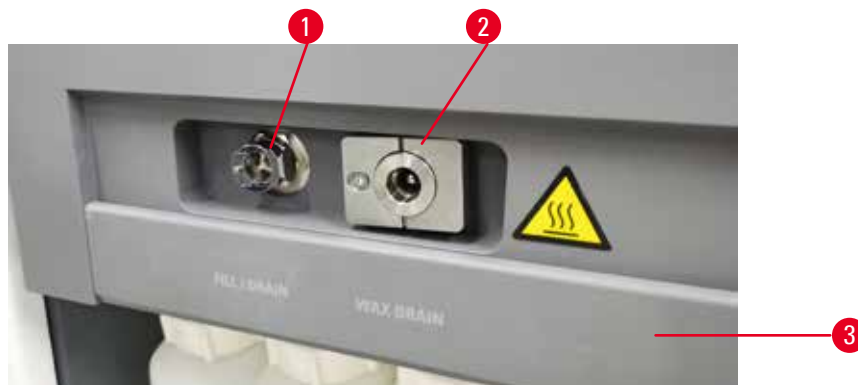

Fig. 75

The remote fill/drain line (→ Fig. 75-1) and the paraffin drain outlet (→ Fig. 75-2) sit beside the active carbon filter on the reagent cabinet. A protective flap (→ Fig. 75-3) covers the outlets. The paraffin waste line is heated to ensure that the paraffin does not solidify during the drain.

- Before draining a paraffin station, open the fill/drain flap and fit the paraffin waste tube to the paraffin waste line. Ensure that:
 - A. the paraffin waste tube drains into a suitable container and
 - B. no part of the tube is submerged in the drained paraffin. This prevents paraffin from solidifying around the end of the tube and blocking it.
 - C. Before filling or draining reagent bottles, connect the remote fill/drain tube to the remote fill/drain line. The tube has a push-fit coupling that ensures a secure connection to the line. To fit the tube, open the fill/drain flap, and push the coupling onto the end of the line. To remove the tube, slide back the locking ring and pull the tube off the remote fill/drain line.



Warning

Fill the reagent from an unstable container.

People injury - The fill/drain functions include a strong purge which may cause an unstable container to tip over and spill. The user may slip on the spilled reagent on the ground.

Environment contamination.

- Always ensure that you fill from or drain to a large stable container. The container must also be of sufficient volume to easily accommodate all of the drained fluid. If you use a small container you must support the container and tube during the fill or drain.
- Always use the tube supplied with the instrument.
- Always wear chemical protective clothing, protective goggles, respirator, rubber gloves, and all other necessary personal protective equipment, when handling the reagents. Reagents used for tissue processing can be both toxic and/or flammable.

7.4.3 Replacing reagent – remote fill and drain



Warning

The connector does not match the tube/Connector corrosion; Reagent bottle overflow (the external reagent quantity does not match the reagent bottle, etc.); Bottle falling during reagent fill or exchange; The tube becomes loose during draining.

People slip or inhale toxic/dangerous fume.

Biohazard because of waste reagent.

Environment contamination.

- Always wear chemical protective clothing, protective goggles, respirator, rubber gloves, and all other necessary personal protective equipment, when handling the reagents. Reagents used for tissue processing can be both toxic and/or flammable.
- Always use the tube supplied with the instrument.
- Never fill a reagent station that has contents already in it.

You can drain and then refill reagent bottles without removing the bottles from the instrument. The process drains each bottle to a retort and then drains the retort to the remote fill/drain line. The reverse procedure is used for the fill.

If you routinely use remote drain and fill, do not forget to check if bottles need cleaning. This should be done once a week.

Before beginning a remote fill or drain, ensure both retorts are available. When a protocol is running in the retort(s), the remote fill/drain cannot be used. It is a design feature, not a malfunction.

- both retorts must not have a protocol loaded or running
- both retorts must be clean or empty and
- both retorts must be clean or the residue in retorts (if any) must be compatible with the reagent in the bottle(s).

Drain

1. Connect the remote fill/drain tube and place the end in a suitable container.
2. From the **Remote fill/drain** screen (**Reagents > Remote fill/drain**), select the:
 - A. retort to use (→ Fig. 76-1)
 - B. **Remote** icon (→ Fig. 76-2)
 - C. bottle(s) to drain (multiple bottles must have reagent of the same type) (→ Fig. 76-3)

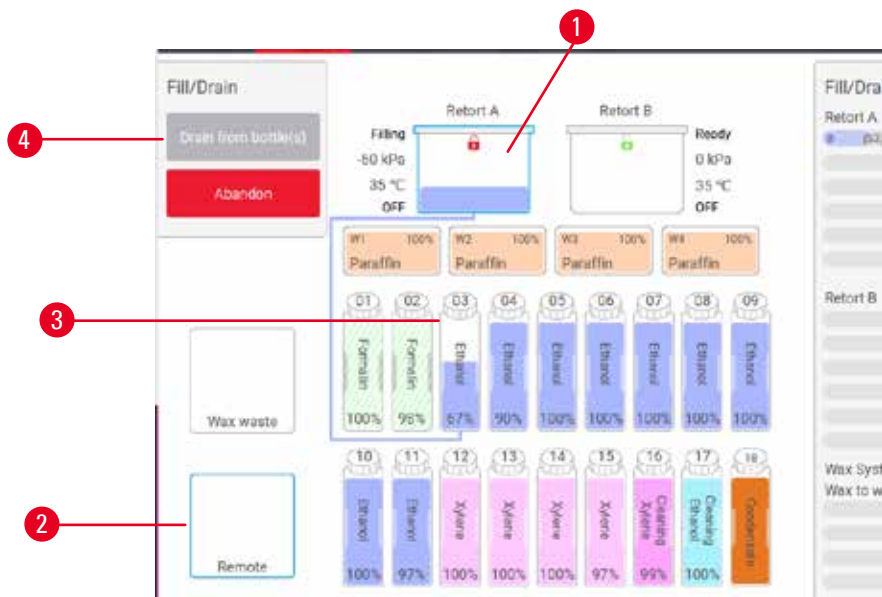

Fig. 76

3. Tap **Drain from bottle(s)** (→ Fig. 76-4) to begin the drain.
4. When prompted, check that the retort lid is closed and the remote fill/drain tube is properly connected.
5. Tap **OK** to begin the drain.

The instrument will now drain the bottle(s) via the selected retort. You can monitor the drain progress in the status panel. When the drain is finished, the retort state will be **Empty** and the bottle state will be **Dry**.

Fill

6. Place the tube into a container of fresh reagent. The fresh reagent must be above 5 °C to ensure that the reagent sensors operate correctly.
7. From the **Remote fill/drain** screen, select:
 - A. The retort to use
 - B. The **Remote** icon
 - C. The bottle(s) to fill. (Multiple bottles must all be **Dry** and set to the same reagent type.)
 Any bottle residue must be compatible with the new reagent.
8. Tap **Fill to bottle(s)** to begin filling.
9. When prompted, check that the retort lid is closed and the remote fill/drain tube is properly connected. Tap **OK** to begin the fill.
10. A confirmation dialog box appears.
11. Confirm that the reagent type, concentration and history details are correct. If not, tap in the appropriate cell and change the value. You can also scan the reagent lot number details. If you set a new reagent type, the station must have already been set to that type ([→ p. 119 – Assigning new reagents to stations](#)). The reagent must be compatible with the retort and bottle residue.
12. Tap **OK** to start the fill.

The instrument will now fill the bottle(s) via the selected retort. You can monitor the fill progress in the status panel. A message will alert you when the fill is complete. The retort will be in an **Empty** state and the bottle in a **Full** state.

**Note**

- At any time during the drain or fill you can tap the Abort button to terminate all current and pending fill/drain operations.
- If you abort a drain when both the retort and bottle are partially full, you must drain the retort back to the original bottle to continue. To drain the retort, deselect the Remote icon then tap the Drain retort button.
- Use a soft dry cloth to clean the surface of the tube before and after remote filling/draining reagents.

Remote fill and drain sequences

The following reagent sequences are recommended when filling and draining multiple bottles:

Order	Drain sequence	Fill sequence
1	Fixatives	Cleaning solvents
2	Cleaning ethanol	Clearers
3	Dehydrants	Defatting solvents
4	Defatting ethanol	Defatting ethanol

Order	Drain sequence	Fill sequence
5	Defatting solvents	Cleaning ethanol
6	Cleaning solvents	Dehydrants
7	Clearers	Fixatives

7.4.4 Replacing reagent – Manually

To replace a bottle manually, remove it from the reagent cabinet and dispose of the old reagent (following your laboratory's standard procedures). Clean the bottle if necessary, and then fill it with fresh reagent. Load it back into the reagent cabinet, making sure that it fits firmly into the connectors at the back of the cabinet.

The reagent bottle must be pushed in the right place according to the reagent definition on the **Status** screen.

When the bottle is reinserted, the **Select a bottle to update** dialog appears, showing the reagent type and concentration for the bottle when it was removed.

When you select a bottle to update, the options available are:

- **Changed** – Enter the reagent concentration, optionally enter the expiry date and lot number details.
- **Topped off/up** – select if you did not change all the reagent but added a small amount of fresh reagent of the same type to bring up its level in the bottle. (With this option the bottle state changes to Full. The concentration and history details do not change.)
- **No change** – select if you made no changes to the reagent in the bottle.
- **Emptied** – select if you emptied the bottle but did not refill it.



Warning

Ignore the information provided by the instrument.

Update reagent/station parameters but not replace the reagent.

Do not update the reagent status on GUI from Empty to Full after filling the bottle.

Or set the status to Full before filling the bottle, but not filling the bottle or underfilling the bottle.

Sample damage caused by dirty or expired reagent, or insufficient reagent.

Delay of diagnosis.

- Always change reagents when prompted.
- Always update station details correctly.
- Never update the details without replacing the reagent.

7.4.5 Replacing paraffin

**Warning**

Open/Close paraffin bath lid; Fill melted paraffin; The connector does not match tube / Connector corrosion; The tube becomes loose during draining; The waste paraffin container is not ready/not stable when draining starts via GUI; Pull out the drain tube.

Hands/fingers get scald.

People slip or inhale toxic/dangerous fume.

Biohazard because of the contaminated paraffin.

Environment contamination.

- Wear chemical protective clothing, protective goggles, respirator, rubber gloves, and all other necessary personal protective equipment when filling/draining melted paraffin. Used paraffin can be contaminated.
- Ensure you use the correct size paraffin drain hose to avoid paraffin leakage.
- The paraffin leaving the tube will be hot and may cause burns. Make sure the paraffin drains to a suitable container and stand clear while it drains.
- Do not remove the remote fill/drain tube until the software indicates the process is complete and pressurized air has cleared the tube. A cessation of reagent flow is not an indication that the procedure is complete.

Before draining the paraffin, make sure that the retorts are not running a protocol or filling/draining reagents. The retorts do not require cleaning.

The paraffin to be drained must be molten.

Drain

1. Connect the paraffin waste tube and place the end in a suitable container.
2. Go to **Reagents > Remote fill/drain** and select the:
 - A. paraffin stations to drain and
 - B. **Paraffin waste** icon.
3. Tap **Drain to waste**.
4. A confirmation message appears asking you to check that the paraffin waste tube is properly connected and feeding into a suitable container.
5. Tap **OK** to begin the drain. The instrument will now drain the chambers. You can monitor the progress in the status panel. Paraffin drains can take up to 5 minutes. When the chambers are completely drained, a dialog will appear and the state of each drained chamber will be **Dry**. Do not remove the paraffin drain tube until the dialog confirms a successful drain.
6. To stop paraffin solidifying in the drain tube, promptly remove the tube from the container holding the drained paraffin.

**Note**

- If no paraffin drains it is likely that the paraffin tube is blocked. If you remove a blocked tube before the drain is aborted, hot paraffin will spurt from the front of the instrument. Abort the drain before removing the tube and melting the paraffin with hot water.
- At any time during the drain, you can tap Abort to terminate all current and pending fill/drain operations.

Fill

7. If you are filling a paraffin chamber with molten paraffin, place the paraffin bath vent plug into the air vent at the rear of the paraffin chambers. This will help prevent paraffin from entering the vent during filling.



Fig. 77

8. Fill the paraffin chamber with molten or solid paraffin.
9. If you placed the paraffin bath vent plug in the air vent, remove the tool.
10. Close the paraffin bath lid.
11. Go to **Reagents > Stations > Paraffin chambers**. The row for the drained paraffin chamber shows the default concentration. It also shows the history values re-set to zero. The station state is **Dry**. The reagent type is unchanged from the paraffin that you drained unless you changed the type assigned to the station after the drain.
12. Tap the State cell for the chamber.
13. If you have added molten paraffin, select **Full**.
14. If using solid paraffin, select **Not molten (requires melting)**.
15. Optionally enter the lot number of the new paraffin.
16. Tap **OK**.
17. If you set the state to **Not molten (requires melting)**, a rapid paraffin heating process begins. You may need to add extra paraffin as it melts. For solid paraffin, fill each empty paraffin bath with approximately 3kg (starting with 2kg to melt, followed by an additional 1kg). Note that the amount of solid paraffin needed may vary with different paraffin suppliers. The level of the molten paraffin should be between MAX and MIN indicators in the paraffin bath.
18. The station's state automatically changes to Full when the paraffin is ready to use.

7.4.6 Filling and draining retorts

**Warning**

The connector does not match the tube/Connector corrosion; Reagent bottle overflow (the external reagent quantity does not match the reagent bottle, etc.); Bottle falling during reagent fill or exchange; The tube becomes loose during draining.

People slip or inhale toxic/dangerous fume.

Biohazard because of waste reagent.

Environment contamination.

- Always wear chemical protective clothing, protective goggles, respirator, rubber gloves, and all other necessary personal protective equipment, when handling the reagents. Reagents used for tissue processing can be both toxic and/or flammable.
- Always use the tube supplied with the instrument.
- Never fill a reagent station that has contents already in it.

The **Remote fill/drain** screen can also be used to drain or fill retorts. This is particularly useful in recovering from incomplete remote fill/drain operations. The retort fill and drain functions operate according to rules designed to avoid reagent contamination, reagent spills and reagent overheating. You can override some of these rules, but this might result in reduced reagent concentration.

You can also fill and drain retorts using the **Manual operations** screen ([→ p. 131 – 8.1.1 Manual operations](#)).

The rules for manually filling and draining retorts are:

- The retort must be clean or empty before you start a retort fill operation.
- If the retort is empty, the selected station must have compatible reagent ([→ p. 169 – 10.5 Reagent compatibility tables](#)).
- You cannot fill a retort with a reagent that has a temperature threshold below the set retort temperature.
- When draining a retort, the reagent/paraffin must be returned to its original station.
- When draining a retort, the station must have sufficient capacity for the retort contents, and shall not be full or in use.

Note: To avoid fluid spills, ensure that there is adequate station capacity before overriding insufficient capacity errors.

To fill or drain a retort:

1. Go to **Reagents > Remote fill/drain**.
2. Select the retort that is to be filled or drained.
3. Select the reagent station that is to fill the retort (or collect the retort's contents).
4. Tap the **Fill retort** or **Drain retort** button.
5. To stop the fill or drain at any stage, tap **Abort**.

8. Ancillary Settings & Operations

8.1 Reagents menu

You can manually control a number of the reagent-handling features of the system from the **Manual operations** screen.

8.1.1 Manual operations

From the **Manual operations** screen (**Reagents > Manual operations**) (→ Fig. 78) you can manually control many aspects of the instrument. All users—operators and supervisors—can perform these functions.



Fig. 78

1. Retort A controls
2. Retort B controls
3. **Fill/Drain retort:** fill or drain the retort from or to the selected station
4. **Access retort**
5. **Paraffin heater:** Enable/Disable heaters for paraffin path
6. **Stirrer:** set the retort stirrer to On/Off
7. **Pressure:** set retort pressure – ambient, vacuum, pressure, or cycle pressure and vacuum
8. **Temp.:** set the retort temperature
9. **Abort:** stop a fill or drain operation
10. **Vent paraffin:** release pressure or vacuum in paraffin chambers

From the **Manual operations** screen, you cannot:

- override a running protocol
- fill or drain a retort that has a loaded protocol.

Retort temperature range

The retort temperature range is limited to the following values:

- **Reagent:** 35 °C – 85 °C maximum (restricted to a maximum of 65 °C when running tissue processing protocols).
- **Paraffin:** Paraffin melting point + 2 °C minimum to 85 °C maximum (restricted to 77 °C when running standard protocols). View the current paraffin melting point on the **Settings > Processing settings** screen.

Additional limitations may apply depending on the retort state and the reagent in the retort. You cannot raise the retort temperature above the safe temperature threshold of the reagent.

Paraffin transfers

The paraffin path (including the paraffin valves and the transfer pipes) and the retort must be at the paraffin standby temperature before you attempt to fill a retort with paraffin. Each retort has a paraffin heater for achieving this.

1. Go to **Reagents > Manual operations**.
2. Activate the paraffin heater by tapping the appropriate **Disabled Paraffin heater** button (→ Fig. 78-5).
3. Click **OK** on the confirmation message. Leave the heater on for at least five minutes.
4. Turn off the heater by tapping the appropriate **Enabled Paraffin heater** button.
5. Click **OK** on the confirmation message.

Filling and draining retorts

Fill (or drain) the retorts from (or to) a reagent station using commands on the **Manual operations** screen. The rules, and procedures, for manually filling and draining retorts are the same as when you do this from the **Reagents > Remote fill/drain screen** (→ p. 130 – 7.4.6 [Filling and draining retorts](#)).

8.2 Administration menu

You can run reports, view event logs, and change access-level settings from the **Administration** menu.

8.2.1 User management

Use the **User management** screen (**Administration > User management**) to manage user accounts.

Adding/Editing/Deleting a user account

- ① After the initial login (→ p. 59 – 5.1.3 Access levels), the Administrator can create Supervisor-level and Operator-level accounts.

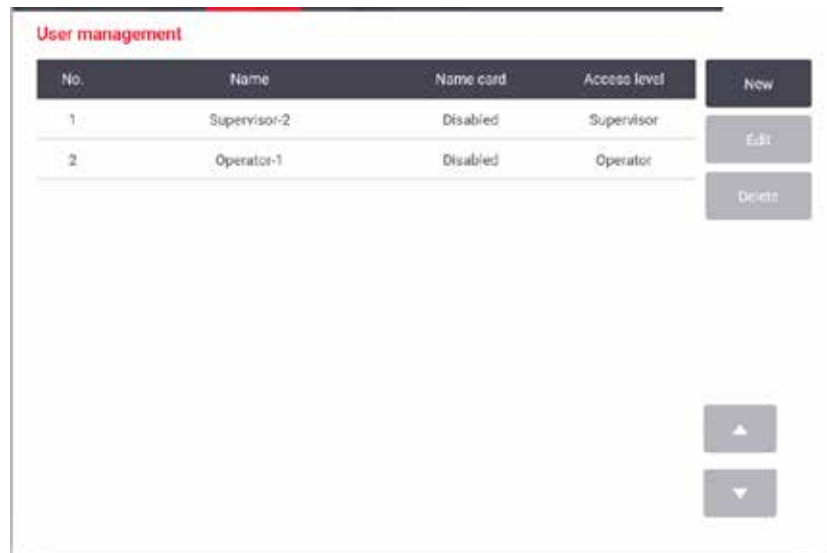

Fig. 79

To add a new user account:

1. Go to the **User management** screen (**Administration > User management**).
2. Tap **New**. The **Add/Edit user** screen appears.
3. Fill in the user name, password, and access level.
4. Scan a barcode to enable the name card. The created user can log on by scanning the barcode on the name card. If the name card is disabled, the created user logs on by the user name and password.
5. Tap **OK**.

To edit a user account:

1. Go to the **User management** screen (**Administration > User management**).
2. Select a user account from the table and tap **Edit**. The **Add/Edit user** screen appears.
3. Change the user name, password, access level, or enable/disable the name card.
4. Tap **OK**.

To delete a user account:

1. Go to the **User management** screen (**Administration > User management**).
2. Select a user account from the table and tap **Delete**.
3. Tap **OK** in the prompted confirmation dialog box.

Change passwords/barcode No.

- ① The administrator can change passwords/barcode No. for all access levels. Supervisors and Operators can change only their own passwords/barcode No..

To change the administrator's passwords:

1. Tap the user name icon on the top right side and tap **Switch user**.
2. The **User login** screen is displayed. Tap **Other access**.
3. The **Access level** screen is displayed. Tap **Change password**.
4. Enter current password, twice new password, and tap **OK**.

To change the passwords/barcode No. of the Supervisor or Operator by their own:

1. Log in as Supervisor or Operator, tap **Administrator > User management**.
2. Select your own account, and tap **Edit**.
3. The **Add/Edit user** screen is displayed. Tap the passwords/barcode No. icon.
4. Enter a new password and barcode No., and tap **OK**.

8.2.2 Reports

Four reports are available from **Administration > Reports**:

- Run details report
- User action report
- Protocol usage report
- Reagent usage report

Run details report

This report provides details of a particular protocol run. When selected, it first displays a list of all protocol runs, those in the previous month or those in the last 30 days (→ Fig. 80). Tap a button at the right of the screen to choose the duration you want.

Protocol runs Clear

End date	End time	Retort	Protocol name	#Cassettes	Started by
2021-09-04	07:17	Retort A	Test-1	150	Administrator
2021-09-04	06:45	Retort A	Test-1	150	Administrator
2021-09-04	06:23	Retort A	Test-1	150	Administrator
2021-09-04	05:58	Retort A	Test-1	150	Administrator
2021-09-04	03:38	Retort A	Test-1	10	Administrator
2021-09-04	03:30	Retort A	Test-1	200	Administrator

Last 30 Days
August
All
Generate

▲
▼

Fig. 80

From the protocol listing, you can display the details of one or more particular runs by selecting them and tapping **Generate**. The **Run Details** report appears, showing details of all the runs you selected (→ Fig. 81). The details provided include the start and end time, user ID, retort, number of cassettes, basket IDs, protocol steps, the station and reagent (with lot number if entered) for each step and the duration of the step. Any significant event that occurred during a protocol run is recorded.

Run details report PXXXX

stanardprotocoitypeinvalidated Invalidated

Run started	Run ended	User	Retort	#Cassettes
2021-06-08 06:48	2021-06-08 06:51	Administrator	Retort A	100

Basket 1: Basket 2:

Step	Station	Type	#Lot	Concentration	Duration(min)
1	S4	85% Ethanol		85.0%	0s

Date	Time	Run stage	User	Event code	Message
2021-06-08	06:48	Step 1	Administrator	13	Protocol paused by user.
2021-06-08	06:49	Step 1	Administrator	4	protocol resumed.

Back
Export

▲
▼

Fig. 81

You can export run details by tapping **Export**. If no USB memory stick is already inserted, you will be prompted to insert a USB memory stick. The CSV file can be saved to a computer and opened in Excel.

User action report

This report lists the user actions that have been entered with a user ID since the beginning of the month (→ Fig. 82). The details can be listed in time order or action order. The user ID is only displayed if the report is run in supervisor mode.

Date	Time	User	Action
2021-06-08	13:53	Administrator	Protocol loaded - Biopsy Xylene with Retort A.
2021-06-08	13:53	Administrator	Protocol loaded - Quick Clean with Retort A.
2021-06-08	13:49	Administrator	Protocol resumed all
2021-06-08	13:48	Administrator	User pause - stanardprotococtypeinvalidate with Retort_A
2021-06-08	13:48	Administrator	Started run - stanardprotococtypeinvalidate with Retort A
2021-06-08	13:48	Administrator	Retort_A: set cassettes number:100
2021-06-08	13:48	Administrator	Retort_A: add baskets count:0
2021-06-08	13:48	Administrator	Try to record basket barcode and cassette image with Retort B
2021-06-08	13:48	Administrator	Protocol loaded - stanardprotococtypeinvalidate with Retort A.
2021-06-08	13:48	Administrator	Protocol copied - Biopsy Xylene1234567890 from Biopsy Xylene
2021-06-08	13:48	Administrator	Protocol created - stationclearvalid

Fig. 82

You can export the user action details by tapping **Export**. If no USB memory stick is already inserted, you will be prompted to insert a USB memory stick. The CSV file can be saved to a computer and opened in Excel.

Protocol usage report

This report lists the number of processing runs, cassettes, and average number of cassettes per run (→ Fig. 83). You can group the data by day, week or month.

Protocol and cassette report - preview

# Runs	Sep-2021	Aug-2021	Jul-2021	Jun-2021	May-2021	Apr-2021	Mar-2021
Test-1	6	0	0	0	0	0	0
Total	6	0	0	0	0	0	0

# Cassettes	Sep-2021	Aug-2021	Jul-2021	Jun-2021	May-2021	Apr-2021	Mar-2021
Test-1	2710	0	0	0	0	0	0
Total	2710	0	0	0	0	0	0

# Cassettes per run	Sep-2021	Aug-2021	Jul-2021	Jun-2021	May-2021	Apr-2021	Mar-2021
Test-1	451	0	0	0	0	0	0
Total	451	0	0	0	0	0	0

Monthly
Weekly
Daily
Export

▲
▼

Fig. 83

You can export the protocol usage details by tapping **Export**. If no USB memory stick is already inserted, you will be prompted to insert a USB memory stick. An Excel-compatible file is generated. Tap **Done** when the transfer is complete.

Reagent usage report

This report lists the total volume of a reagent used by tracking when it is changed (→ Fig. 84). You can display the data by day, week or month.

Reagent change report - preview

Reagent(Ltr)	Sep-2021	Aug-2021	Jul-2021	Jun-2021	May-2021	Apr-2021	Mar-2021
Ethanol	3.5	0	0	0	0	0	0
Formalin	3.5	0	0	0	0	0	0

Monthly
Weekly
Daily
Export

▲
▼

Fig. 84

You can export the reagent usage details by tapping **Export**. If no USB memory stick is already inserted, you will be prompted to insert a USB memory stick. An Excel-compatible file is generated. Tap **Done** when the transfer is complete.

8.2.3 Event logs

The event log (**Administration > Event logs**) displays a history of system events. You can sort the events by time or by frequency. You can also filter events by the type of event you want to view. You can add a message and save it as a user event.

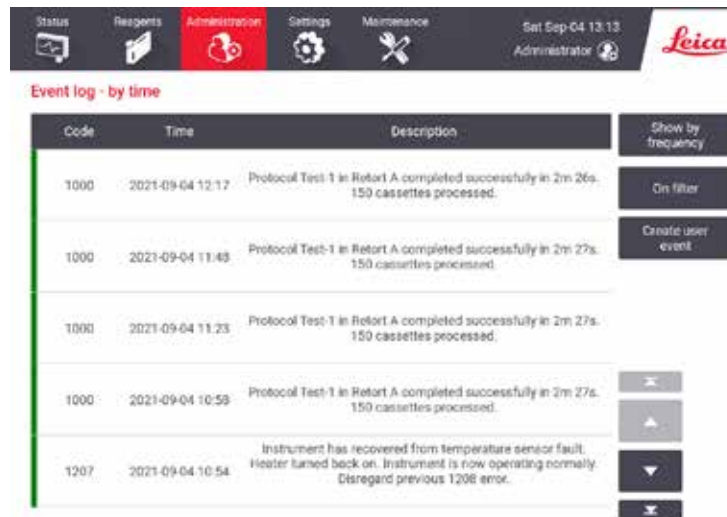

Fig. 85

In the show-by-time view, each event instance is listed with the most recent events at the top of the screen. Each event has the event type number, the event severity color code (→ p. 139 – Event severity), the time the event occurred, and the event description.

In the show-by-frequency view, there is one row for each event type number, e.g. all the 1000 events—“protocol completed successfully”—are represented in one row. As well as the event number, severity color code and description, the number of instances of the event and the dates and times of the first and last instances of the event are shown.

The event log can only be cleared by service personnel.

- Tap the **Show by time/Show by frequency** button to switch between the two views.
- Tap the **On filter** button to open the **Configuration options ...** dialog box where you can select the types of events to view. Select buttons in the **Retort filter**, **Severity filters**, and **Alarm filters** sections to see the associated types of events. You must select at least one button in each section to see any events. For example, if you select **Retort A** in the **Retort filter**, **Information** in **Severity filters** and **Non-alarmed events** in **Alarm filters**, you will see all information events for retort A that did not raise an alarm.
- To create a user event, select **Create user event**. This opens the on-screen keyboard. Type in the information you want to record and tap **Enter** to add the message as an event. The event severity will be “Information”.

Event severity

There are three event severity levels and each has a color code:

Color code	Severity level	Description
Green	Information	A normal event that requires a response (e.g. a protocol successfully completed) or an unusual event that has no detrimental effect (e.g. a user aborted protocol).
Orange	Warning	An error or potential error that does not stop processing, or a request for user action. For example, an out-of-threshold reagent used in a protocol.
Red	Error	An error that causes an operation to abort (e.g. because there is no station available), or makes part of the instrument (e.g. one retort) or the entire instrument unusable.

8.3 Settings menu

The settings screens enable you to view instrument and software information, export and import files, alter certain hardware settings, and manage alarms.

8.3.1 Service

Go to **Settings** > **Service** to view instrument and software information.

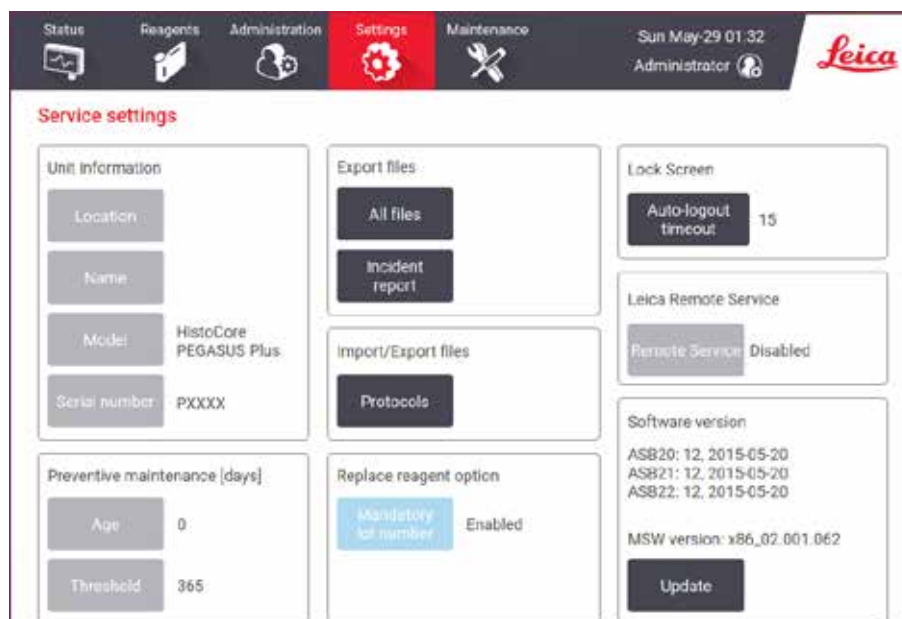

Fig. 86

The **Unit information** area shows the instrument name, location, model and serial number. All values are read-only.

The **Preventive maintenance** area shows the age and threshold of the preventive maintenance service.

The **Replace reagent option** area shows the status of **Mandatory lot number**, enabled or disabled. If the **Mandatory lot number** is enabled, the reagent lot number is required when replacing a reagent.

The **Lock screen** area shows the current auto-logout time. Supervisors can change the time.

The **Leica Remote Service** area shows the availability of **Remote Service**. When connected to the remote service, the instrument will actively send events to the remote server. Set up the network connection (→ p. 145 – [Network](#)), and get optimized service from Leica Biosystems.

The software area displays the current software version numbers. The software version may be needed when reporting a fault. Supervisors can update the software by tapping the **Update** button.

Export files

The Export files options on the **Service** screen enable you to copy protocol files, incident reports, and log files to a USB memory stick. You can also import protocol files from a USB memory stick.

All users—operators and supervisors—can transfer files.

The available file transfer options are explained below:

- All files – select this option if you want to export all files from the system to a USB memory stick. In the popped-up window, select the time range and the file types, then tap **OK**.
- Incident report – select this option if you want to create and export an incident report.
- Protocols – select this option if you want to move custom protocols between the system and a USB memory stick. The procedure is described in detail in the next section.

Transferring protocols

① Operators can only export protocols.

1. Place a USB memory stick into the USB port on the left side of the display. It is important that you insert the USB memory stick at the start of this procedure, otherwise its contents may fail to be recognized.
2. Tap **Settings > Service > Protocols**. A screen appears showing the local protocols (that is, the user-defined protocols on the instrument) and the remote protocols (that is, user-defined protocols at the root level of the USB memory stick, if there are any). Protocols stored in directories on the stick will be ignored.
3. Tap **Refresh** to ensure that the protocol lists are current.
4. To copy all user-defined protocols from the instrument to the memory stick, tap **Export all**.
5. To copy one user-defined protocol from the instrument to the memory stick, select it from the **Local protocols** list and tap **Export**.
6. To copy all the protocols listed on the memory stick to the instrument, tap **Import all**.
7. To copy one user-defined protocol from the memory stick to the instrument, select it from the **Remote protocols list** and tap **Import**.
8. Tap **Done** when you have finished.

8.3.2 Processing settings

**Warning**

The RMS (Reagent Management System) is set to N/A or a wrong value.

The reagent consumption status can not be monitored, which may impact the tissue processing quality and cause sample damage.

- Do not set the RMS to N/A. Use RMS to monitor reagent consumption status.
- The RMS settings must be validated by the user before running the protocol, i.e. tissue processing with patient tissue for diagnostics, according to the local or regional accreditation requirements.

On the **Processing settings** screen (**Settings > Processing settings**) supervisors can:

- Enable/Disable the prompt for the number of cassettes before running a processing protocol
- Set the default number of cassettes per run
- Set the default carryover value
- Turn paraffin cleaning on and off
- Set the default cleaning protocol
- Set paraffin standby and melting point temperatures.
- Enable/Disable paraffin cleaning function
- Set the paraffin type

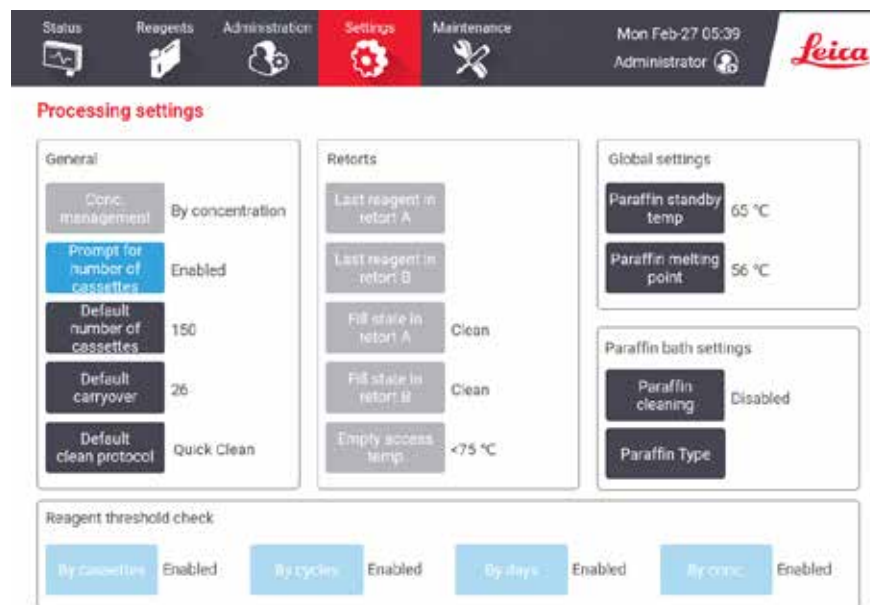

Fig. 87

A range of other configuration settings can be viewed but not changed. Contact customer support to change any of these. The screen also displays the state of each retort and the last reagent in each retort.

Controls on the **Processing settings** screen are described below, grouped by section.

General

- **Conc. Management:** the method the system uses to assign concentration values to reagent bottles ([→ p. 105 – 7.1.2 Concentration management](#)).
- **Prompt for number of cassettes:** with the default setting (**Enabled**) the system prompts you to enter the number of cassettes before each run. When the function is disabled, the system assumes that each run processes the default number of cassettes.
- **Default number of cassettes** – set the default number of cassettes for each processing run. If **Prompt for number of cassettes** is enabled, the prompt dialog box opens before each run showing this number of cassettes. You can accept or change the number. If **Prompt for number of cassettes** is disabled, the system uses the number of cassettes entered here for all processing runs. In this case be sure to enter an accurate average value. The number is used by the reagent management system to calculate reagent concentrations.
- **Default carryover** – the default carryover setting used for new protocols ([→ p. 93 – 6.1.5 Carryover setting](#)).

Reagent threshold check

The four buttons in the **Reagent threshold check** section of the **Processing settings** screen show which types of reagent thresholds the system is using ([→ p. 106 – 7.1.3 Thresholds](#)). By default, all four threshold types are enabled. Contact your customer support representative to change any of these settings.

- **By cassettes** – the system tracks the number of cassettes processed by the reagent in each station. If the reagent type has a cassette threshold set, you are alerted when the station goes beyond that threshold.
- **By cycles** – the system tracks the number of processing runs performed by the reagent in each station. If the reagent type has a cycle threshold set, you are alerted when the station goes beyond this threshold.
- **By days** – the system tracks the number of days the reagent in each station has been loaded. If the reagent type has a days threshold set, you are alerted when the station goes beyond that threshold.
- **By conc.** – the system tracks the concentration of reagent in each station. If the reagent type has a concentration threshold set, you are alerted when the station goes beyond this threshold.

Retorts

The **Retorts** section of the **Processing settings** screen shows the state of, and last reagent used in, each retort. It also shows the empty access temperature (that is, the temperature up to which it is safe to open empty retorts). The system warns you if you begin an action that requires you to open a retort when the temperature inside it exceeds this value.

Paraffin bath settings

Turn paraffin cleaning on and off with the **Paraffin cleaning** button on the **Processing settings** screen. The paraffin cleaning function improves the quality of the paraffin by periodically evacuating the paraffin bath (for approximately 30 seconds) to draw off any contaminants. You may need to periodically add small amounts of paraffin to replace solvents that have been removed.

- Enable paraffin cleaning for protocols that use xylene and/or IPA.
- Disable paraffin cleaning for protocols that do not use IPA, as these clearers are not efficiently removed by the evacuation process.

By removing contaminants, paraffin cleaning increases paraffin concentrations. The system automatically updates the concentration of each paraffin station after each paraffin cleaning cycle.



Note

- Paraffin cleaning can delay the start of a protocol or other action by up to 30 seconds.

Paraffin type can be set as **Recommended** or **Not Recommended**.

- Set the paraffin type as **Recommended** for recommended paraffins (→ p. 109 – 7.1.4 [Recommended reagents](#)). The melting time is less than 7 hours.
- Set the paraffin type as **Not Recommended** for other paraffins. The melting time is less than 9 hours.

Global settings

Set the paraffin melting and paraffin standby temperatures in the **Global settings** section of the **Processing settings** screen.

- The paraffin standby temperature is the temperature the instrument heats the paraffin to in the paraffin stations. The default temperature is 65 °C.
- The paraffin melting point is the temperature at which the instrument considers the paraffin molten. The default temperature is 56 °C.

8.3.3 Instrument settings

Use the **Instrument settings** screen (**Settings** > **Instrument settings**) to configure the active carbon filter age and threshold, the date and time display, manual operation manual drain drip time, and the network settings. Supervisor access is required for all operations.

You can also close down the instrument from this screen. Other settings on the **Instrument settings** screen can be viewed but can only be changed by a service representative.

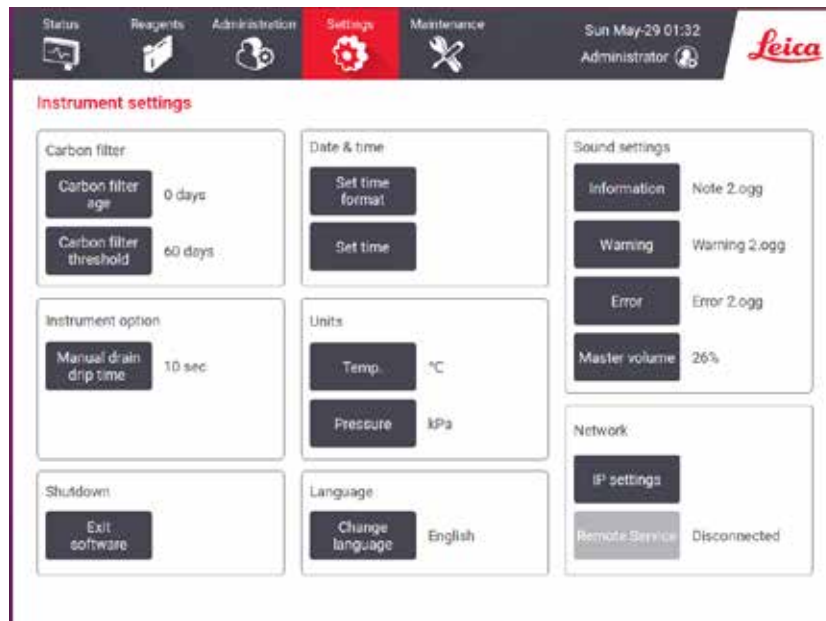

Fig. 88

Active carbon filter settings

Tap the **Carbon filter age** button to reset the age of the active carbon filter to zero days. You should do this when replacing the active carbon filter so that the system can track the filter's age and provide an accurate warning when it exceeds its age threshold.

Tap the **Carbon filter threshold** button to set the number of days a filter can be used before it should be replaced. The correct threshold value depends on the average number of protocols you run each day and the type of reagents used. We recommend an initial threshold of 60 days with adjustments only if you are sure the active carbon filter is becoming saturated earlier, or is still in good condition after this time.

If you are using an external exhaust system, set the active carbon filter threshold to either:

- The inspection interval for the external system
- The maximum value (365) to limit the number of unwanted warnings
- Overridden (contact your service representative to arrange this setting)

Manual drain drip time

Supervisors can change the drip time for manual drain operations. The drip time is the time the system waits for reagents to drip from cassettes and retort walls before completing the drain operation.

Tap the **Manual drain drip time** button, enter the required number of seconds and tap **OK**.

Instrument shutdown

Tap **Exit software** to turn off the instrument in an orderly manner. When the touch-screen goes blank, turn off the red power button.

Time and date

Only supervisors can change the system time.

- To change time and date formats, tap **Set time format** and then tap the format you want to change to. Modify other formats as required and then tap **Done**.
- To change the system time, tap **Set time**, rolling up and down until the correct time is reached, and then tap **OK**.

Language and unit settings

Language settings can be changed by Supervisor. Tap **Change language** and select the language you need. To change the instrument's Unit settings, tap **Temp.** or **Pressure**.

Sound settings

Supervisors can select from a range of sounds that are to be emitted for messages of information, Warnings, and Errors. There is also volume control for all instrument sounds.

- To change the sound associated with a message type, tap the message type button in the **Sound settings** table. Select a sound file in the **Select a sound from the following list** dialog box and tap **OK**. To hear a sound in the **Select a sound from the following list**, select it and tap **Play**.
- To change sound volume tap **Master volume**.

Network

For the initial connection to the remote service, contact the authorized service representative.

Supervisors can connect/disconnect the instrument to Leica remote service if the **Leica Remote Service** is enabled on the **Service settings** screen (→ p. 139 – 8.3.1 Service). Before setting up the connection, make sure that the instrument is connected to the network via the ethernet port located at the rear side of the instrument. Tap the **IP settings** button to configure the network, then tap **Remote Service**. The connecting status is displayed beside the **Remote Service** button.

8.3.4 Tracking options



Fig. 89

Use the **Tracking options** screen (**Settings > Tracking options**) to enable/disable **Track basket**, **Recommended protocol**, and **Camera function**.

Track basket

When the **Track basket** function is enabled, you can fill in the baskets names (→ Fig. 90-1) (→ Fig. 90-3) by scanning or typing baskets barcodes during adding baskets into retorts.

Recommended protocol

Supervisors can set up the linkage between the barcode of a basket and a recommended protocol. The protocol must be validated. A cleaning protocol cannot be selected as a recommended protocol.

A recommended protocol can link to multiple basket IDs. A basket ID can only have one linkage with one recommended protocol. The system compares loaded protocol with recommended protocols automatically according to the barcode of a basket when a basket is loaded. If the loaded protocol is not the same as the recommended protocol or the two loaded protocols are not the same, a warning message will pop up and you have to confirm or change the loaded protocol.

To add a new recommended protocol, follow these steps.

1. Tap the **New** button.
2. Fill in the detail of the basket and protocol, including basket ID, color, protocol name, and tissue type.
3. Tap **OK**.

To edit a recommended protocol, tap the cell you want to update and make changes.

To delete a recommended protocol, select the protocol by tapping the **No.** cell of the protocol, and tap **Delete**.

Camera function

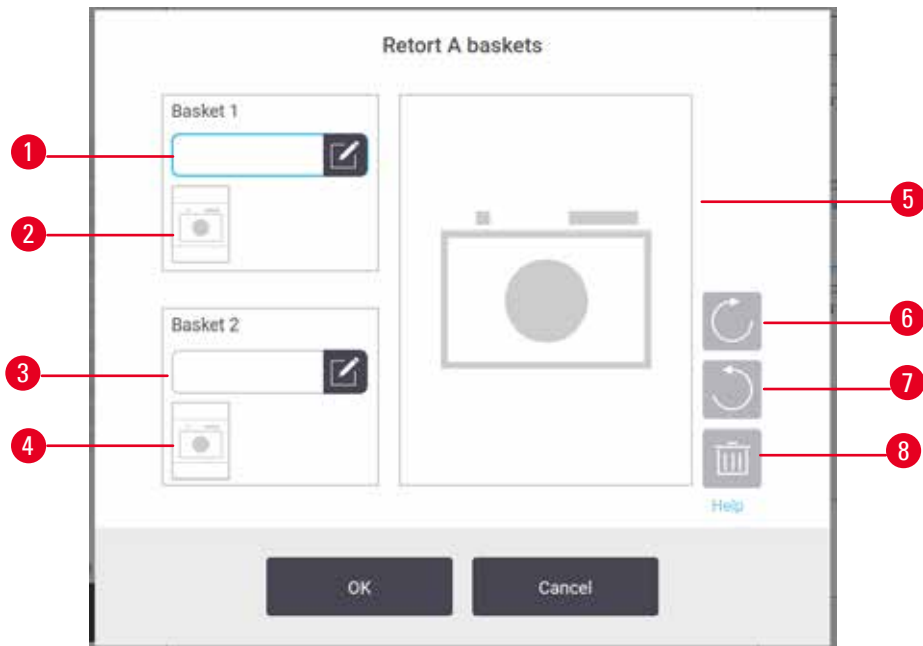

Fig. 90

When the **Camera function** is enabled, you can take pictures for the baskets (→ Fig. 90-2) (→ Fig. 90-4) after the basket barcode is scanned during adding baskets into retorts. Picture view (→ Fig. 90-5) can be adjusted using the rotate buttons, clockwise (→ Fig. 90-6) and counterclockwise (→ Fig. 90-7). Delete the picture (→ Fig. 90-8) and reshoot if needed.

9. Cleaning and Maintenance



Warning

Use improper equipment during maintenance.

People injury – Users are hurt by hot surface/ sharp edge/ residues, etc.

- Wear PPE during maintenance.

Follow the maintenance and cleaning instructions in this chapter to keep the instrument in good working order. This will help ensure quality processing at all times, and avoid unnecessary service calls.

Ensure that the instrument is left on at all times, even when not in operation. This keeps paraffin molten and allows preventative maintenance routines controlled by the software to be carried out.

Leica Biosystems recommends a preventative maintenance call once a year. Contact your service representative to organize a call.

Do not use any cleaning materials or methods other than the ones described in this chapter. The use of other materials and methods may damage the instrument.

9.1 Cleaning and maintenance tools

The cleaning and maintenance tools can be stored in the tool box (→ Fig. 1-11). The tools include:

- a paraffin scraper
- a level sensor brush
- a paraffin bath vent plug

9.1.1 Paraffin scraper

The paraffin scraper can be used to scrape paraffin from around the seals of a paraffin bath lid and from the top of a paraffin bath.

9.1.2 Level sensor brush

The Level sensor brush can be placed inside the sensor and gently scrub, which ensures all sides of the sensor are clean of debris.



Fig. 91

9.1.3 Paraffin bath vent plug

The paraffin bath vent plug can be inserted into the paraffin bath air vent. This will help prevent paraffin from falling into the instrument when you are cleaning around the top surface of the paraffin baths.

9.2 Maintenance screen

The **Maintenance** screen provides a way to record the activity and timing of routine maintenance functions.

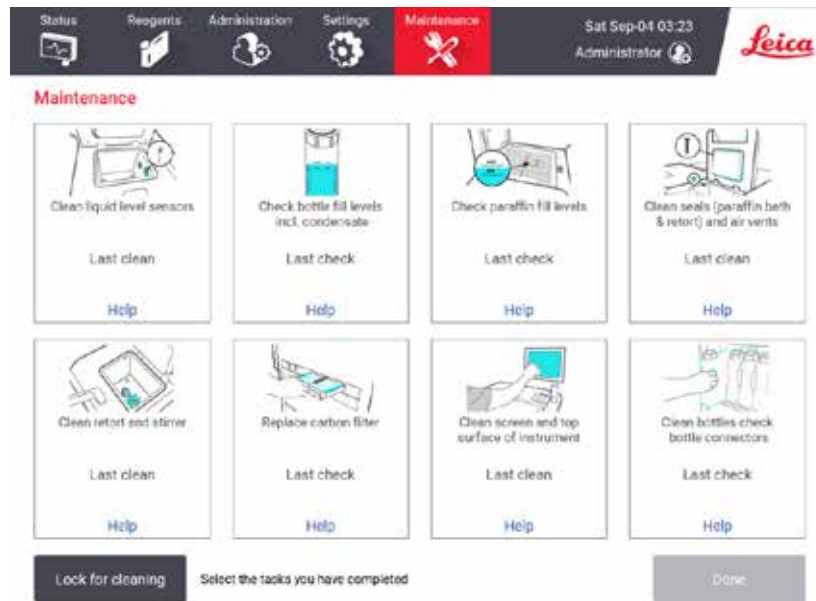

Fig. 92

The eight panels on the **Maintenance** screen consist of:

- an image of the instrument showing what needs to be done (sometimes highlighted in blue)
- a title
- an indicator of when the item was last checked or cleaned, and the operator who did it
- a link to context-sensitive help instructions.

To record a maintenance task:

- tap the panel for the maintenance task you have done or are about to do
- tap **Done**.

Recorded maintenance tasks can be viewed in the **User action report** (**Administration > Reports > User action**).

Screen maintenance

To lock the screen, tap the **Lock for cleaning** button. The clean screen dialog box opens. You can safely clean the screen without accidentally selecting any controls while this dialog box is open.

When finished cleaning, tap the clean screen buttons in the correct order. This unlocks the screen and returns it to normal operation.

9.3 Cleaning and maintenance schedule

See the list below for regular cleaning and maintenance tasks and how often they should be done.

The table below is a weekly maintenance and cleaning checklist that you can print to use as a record of maintenance tasks. Initial the relevant cells in the table as tasks are carried out.

Daily

- Clean lids and seals
- Clean retorts and liquid level sensors
- Check bottle fill levels (including condensate bottle)
- Check paraffin fill levels
- Clean touch-screen and top surface
- Check drip tray

Weekly

- Empty condensate bottle
- Clean reagent bottles and check bottle connectors
- Check paraffin baths
- Clean exterior surfaces

60–90 Days

- Change active carbon filter
- Check lid seals

Maintenance checklist

Week:										Serial No:					
	Mon		Tues		Wed		Thurs		Fri		Sat		Sun		
Date:															
Daily Tasks															
Clean lids and seals															
Clean retorts															
Clean liquid level sensors															
Check reagent levels	Initial	OK/ T/C	Initial	OK/ T/C	Initial	OK/ T/C	Initial	OK/ T/C	Initial	OK/ T/C	Initial	OK/ T/C	Initial	OK/ T/C	
Checked = OK Topped off/up = T															
Changed = C															
Bottle 1															
Bottle 2															
Bottle 3															
Bottle 4															
Bottle 5															
Bottle 6															
Bottle 7															
Bottle 8															
Bottle 9															
Bottle 10															
Bottle 11															
Bottle 12															
Bottle 13															
Bottle 14															
Bottle 15															
Bottle 16															
Bottle 17															
Paraffin 1															
Paraffin 2															
Paraffin 3															
Paraffin 4															
Clean top surface															
Clean touch-screen															
Check drip tray															
Weekly Tasks															
Empty condensate bottle															
Check reagent bottles															
Clean paraffin bath															
Check bottle connectors															
Clean exterior surfaces															
Every 60–90 Days															
Change active carbon filter															
Check lid seals															

9.3.1 Daily Tasks

Clean seals (paraffin bath & retort) and air vents

Use the plastic scraper provided to scrape paraffin off the inside surfaces of the retort and paraffin bath lids. Replace any seals that are damaged (→ p. 160 – Check lid seals).

Scrape around the rims of the retorts, and around the paraffin bath on the top of the instrument where the lids sit. Ensure that the lids seal fully when closed.

In the paraffin bath, make sure that the air vent (→ Fig. 93-1) on the back rim under the left lid is clear of paraffin. Use the paraffin bath vent plug to block the paraffin air vent while cleaning. This will prevent paraffin from falling into the paraffin vent.



Fig. 93

When complete, record this maintenance on the **Maintenance** screen by tapping the appropriate panel:

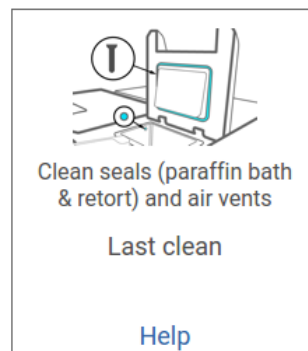

Fig. 94

A pop-up screen with instructions is available by tapping **Help**.

Clean liquid level sensors

Fig. 95

Clean the liquid level sensors (→ Fig. 97-2) daily. Use a lint-free cloth moistened with 70% ethanol to clean. Moisten the tip of the liquid level sensor cleaning brush (→ Fig. 95-1) with ethanol. Place the level sensor brush inside the sensor and gently scrub (→ Fig. 95). Ensure all sides of the sensor are clean of debris. For particularly dirty sensors, use a solution of 6% acetic acid instead of ethanol.

When complete, record this maintenance on the **Maintenance** screen by tapping the appropriate panel:

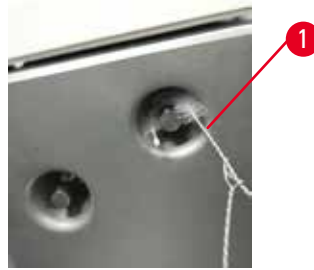

Fig. 96

A pop-up screen with instructions is available by tapping **Help**.

Clean retort and stirrer

Fig. 97

- Clean the retort walls daily. Use a lint-free cloth moistened with 70% ethanol to clean.
- Ensure that the air hole (→ Fig. 97-1) remains unobstructed.
- If you cannot remove stains with ethanol solution, use a lint-free cloth moistened with 6% acetic acid or CLR®. Wipe the surfaces again with ethanol.
- Inspect the retort filter (→ Fig. 97-3).
 - a. Release the retort filter by rotating it upwards.
 - b. Wash it thoroughly in a solution of 70% ethanol.
 - c. Rotate it back into place.

**Warning**

Blockage by losing cassettes/tissues from retort or impurities from reagents or paraffin

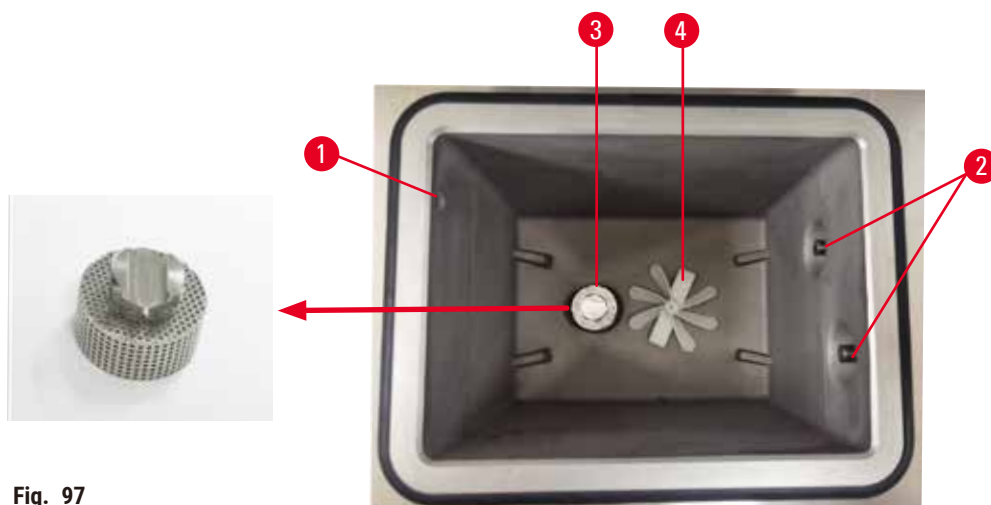
Sample damage

- Use baskets during processing. Do not put the specimens into the retort directly.
- Check that the retort filter is installed at the retort bottom before running a protocol.
- Take care not to drop anything into the retort when the retort filter is removed. Foreign material in the pipes could stop valves from operating properly.

- Inspect the stirrer (→ Fig. 97-4). If it is dirty, lift it out and clean with 70% ethanol. If it is damaged, contact your service representative for a new stirrer.

When complete, record this maintenance on the **Maintenance** screen by tapping the appropriate panel:

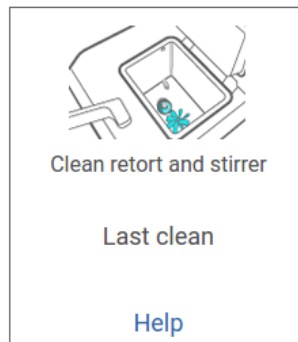

Fig. 98

A pop-up screen with instructions is available by tapping **Help**.

Check bottle fill levels (including condensate bottle)

Ensure that all reagent bottles are filled to between **MIN** and **MAX** marks. Add more reagents if required (→ p. 122 – 7.4 Replacing reagents). Do not fill above the **MAX** mark.

Empty the condensate bottle if it is more than half full.

When complete, record this maintenance on the **Maintenance** screen by tapping the appropriate panel:



Fig. 99

A pop-up screen with instructions is available by tapping **Help**.

Check paraffin fill levels

Ensure that the paraffin baths are filled to between **MIN** and **MAX** marks. Add more paraffin if required (→ p. 122 – 7.4 Replacing reagents). Do not fill above the **MAX** mark.

When complete, record this maintenance on the **Maintenance** screen by tapping the appropriate panel:

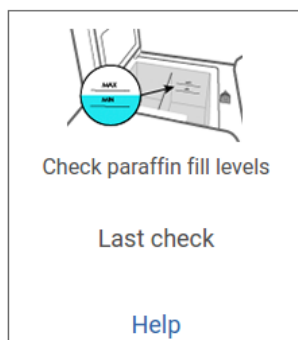

Fig. 100

A pop-up screen with instructions is available by tapping **Help**.

Clean the screen and top surface of the instrument

Lock the touch-screen before cleaning by tapping **Lock for cleaning**. Wipe the touch-screen (or touch-screen protector) with a lint-free cloth moistened with 70% ethanol. Never use abrasive cleaners or strong solvents on the touch-screen.

Use a lint-free cloth with 70% ethanol and, if necessary, the plastic scraper to clean the lids and other surfaces on the top of the instrument. Use the paraffin scraper to ensure all paraffin is removed. When complete, record this maintenance on the **Maintenance** screen by tapping the appropriate panel:

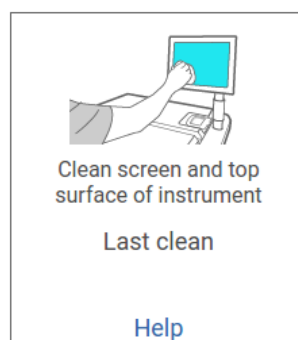

Fig. 101

A pop-up screen with instructions is available by tapping **Help**:

9.3.2 Weekly tasks

Clean reagent bottles and check bottle connectors

Check all bottles weekly. Note those bottles that are becoming dirty. Clean the bottles when next replacing reagent.

While bottles are removed, wipe the interior of the reagent cabinet with 70% ethanol.

To clean the bottles, pour in a small amount of fresh reagent (i.e. the reagent the bottle is used for), cap the openings, and shake. Use sealing caps from Leica Biosystems to seal the bottle. Empty the bottle and check that it is clean. If so, refill it and replace it in the instrument. See (→ p. 122 – 7.4 Replacing reagents) for instructions to reset the station properties.

If the bottle is still stained, use a bottle brush and laboratory detergent to clean it. Rinse thoroughly with water. Then prepare the bottle to refill it with reagent:

- For formalin and ethanol bottles (where the reagent is miscible with water), rinse with a small amount of the bottle's reagent to clear the water and then refill.
- For clearer and cleaning solvent bottles (e.g. xylene, where the reagent is not miscible with water), dry thoroughly before adding fresh reagent, or rinse with a small amount of ethanol and then a small amount of the bottle's reagent before refilling.

The bottle connectors that plug into the instrument can become loose. Check the connector (→ Fig. 102-1) whenever you pull out a bottle. Tighten firmly if necessary.

Check that the O-ring (→ Fig. 102-2) on the back of the bottle is smooth and undamaged. If the O-Ring is not smooth, or resistance is felt when putting the reagent bottle back, lubricate the O-ring with Molykote grease for sealing rings and easy removal of bottles.

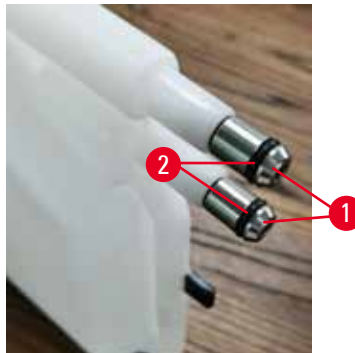

Fig. 102

When complete, record this maintenance on the **Maintenance** screen by tapping the appropriate panel:

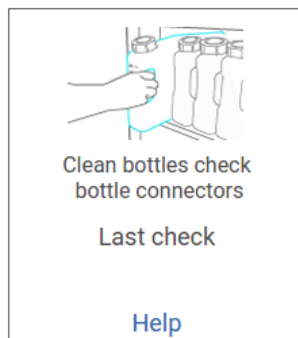

Fig. 103

A pop-up screen with instructions is available by tapping **Help**.

To avoid splashes when cleaning bottles, wear suitable protective clothing and eye-wear.

To avoid reagent spills, ensure that lids are tight and the bottles are firmly plugged into their connectors at the back of the reagent cabinet.

Do not clean reagent bottles in an automatic dishwasher, as they may be damaged.

Check paraffin baths

Check the paraffin baths weekly to see if they are becoming dirty. Clean the baths when you are next replacing the paraffin.

Clean the paraffin baths while they are warm (as they will be immediately spent out after having been drained from the instrument). Never attempt to clean a bath while the paraffin from the bath is in a retort.

Remove any debris or sludge from the bottom and sides of the bath by wiping them with a lint-free cloth. Be careful not to dislodge or remove the chimney filters. Use the paraffin bath vent plug to ensure that paraffin does not go down the paraffin bath vent.



Warning

Open a paraffin bath lid when there is paraffin in a retort or paraffin is being transferred.

People injury

- Never open a paraffin bath lid when there is paraffin in a retort or paraffin is being transferred. Hot paraffin may splash out of the bath.

Take care when cleaning the paraffin bath walls. The walls could be hot and may cause burns.

Clean exterior surfaces

Wipe down the exterior surfaces of the instrument weekly with a cloth dampened with water or 70% ethanol. Do not use strong solvents.

Dry with a lint-free cloth.

9.3.3 60–90 Days

Change active carbon filter

Change the active carbon filter every 60 to 90 days.

Always replace the active carbon filter when the software indicates that it has expired. Running the instrument with an out-of-date active carbon filter may release potentially dangerous fumes into the laboratory.

Administrator should ensure that the active carbon filter threshold is set to a suitable value so that operators will be alerted when the active carbon filter needs to be changed. The active carbon filter threshold setting can be found in **Settings > Instrument settings**.

To replace an active carbon filter:

1. Open the remote fill/drain cover.
2. Remove the active carbon filter by pulling its woven belt on the front side.
3. Remove a new filter from its plastic wrap.
4. Insert the new filter into the instrument. The date on which the filter has been inserted can be marked on the label on the front side.
5. Close the remote fill/drain cover.

When complete, record this maintenance on the **Maintenance** screen by tapping the appropriate panel:

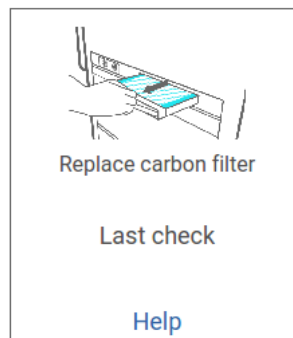

Fig. 104

A pop-up screen with instructions is available by tapping **Help**.

Check lid seals

Every 60–90 days, inspect the seals around the retort lids and paraffin bath lids. Call service to replace a seal if it is worn or damaged.

10. Reference

10.1 Reagent threshold guidelines

The tables in this section list the recommended thresholds for commonly used reagents. There are separate tables for xylene and xylene-free processing.

Xylene processing

For the best results, xylene-processing reagent changes should be based on concentration thresholds, while cleaning reagent thresholds should be based on cycles.

Thresholds for xylene-processing reagents, including cleaning reagents, using non-graded ethanol are:

Type	Reagent change thresholds		Final reagent thresholds		Max. temperatures °C		
	Conc. (%)	Cassettes or cycles	Conc. (%)	Cassettes or cycles	Ambient	Vacuum	Safe
Formalin	98.0	N/A	N/A	N/A	60	60	45
Ethanol	51.0	N/A	98.0	N/A	78	51	45
Xylene	68.0	N/A	95.0	N/A	138	99	45
Paraffin	80.0	N/A	95.0	N/A	100	100	77
Cleaning xylene	N/A	10 cycles	N/A	N/A	138	99	45
Cleaning ethanol	N/A	10 cycles	N/A	N/A	78	51	45

Xylene-free processing

In general, xylene-free processing reagent changes should be based on concentration thresholds, and cleaning reagent changes based on cycles.

Type	Reagent change thresholds		Final reagent thresholds		Max. temperatures °C		
	Conc. (%)	Cassettes or cycles	Conc. (%)	Cassettes or cycles	Ambient	Vacuum	Safe
Formalin	98.0	N/A	N/A	N/A	60	60	45
85% ethanol	50.0	N/A	N/A	N/A	87	55	45
80/20 ethanol/IPA	81.0	N/A	N/A	N/A	78	51	45
IPA	90.0	N/A	95.0	N/A	82	55	45
Paraffin	85.0	N/A	95.0	N/A	100	100	77
Cleaning Waxsol	88.0	6 cycles*	N/A	N/A	100	100	45
Cleaning ethanol	88.0	6 cycles*	N/A	N/A	78	51	45

* This differs from the recommendation for cleaning ethanol in xylene processing because the cleaning solvent in xylene-free protocols is less efficient than the cleaning solvent in xylene protocols.

10.2 Protocols

The protocols in this section have been developed, and extensively tested, by Leica Biosystems for use on the tissue processor. Some are included as pre-defined protocols with the system.

When used for the recommended tissue types, the protocols all produce optimum processing quality with consistent, high-quality results. Use these protocols and the suggested station configurations (→ p. 166 – 10.3 Station configurations) as a reference point when developing protocols that suit your specific requirements and practices.

10.2.1 Specimen type and protocol duration

The following table lists recommended protocol durations for different specimen types.

Protocol (hours)	Maximum tissue thickness (mm)	Specimen type: Examples
3	<ul style="list-style-type: none"> • <3 • =3 	<ul style="list-style-type: none"> • All biopsies up to 3 mm diameter: gastrointestinal biopsies, renal, prostatic, hepatic and breast cores; punch biopsies of skin, small colonic polyps • Small specimens of non-dense tissues (e.g. kidney, liver, bowel), excisional and incisional skin biopsies; skin ellipses
12	<ul style="list-style-type: none"> • 20 × 10 × 4 	<ul style="list-style-type: none"> • All routine tissues up to maximum dimensions (excluding brain specimens) • All routine tissues up to maximum dimensions. Very thick fatty specimens may require a longer protocol.

10.2.2 List of pre-defined protocols

Leica Biosystems provides 5 pre-defined protocols with each system. You can use these as they are, or base new protocols on them (→ p. 99 – 6.2.3 Creating new protocols).

The pre-defined protocols are:

- Biopsy Xylene
- Overnight Xylene
- Biopsy Xylene-free
- Overnight Xylene-free
- Quick Clean



Warning

Inappropriate carryover settings for the sample types being processed can cause sample damage!

To ensure correct carryover settings:

- For carryover settings, please refer to Chapter 6.1.5 'Carryover setting'.
- The pre-defined and customized protocols (carryover value included) must be validated by the laboratory according to their standard operating procedure.

10.2.3 Xylene protocols

All the xylene protocols below are designed for use with the xylene bottle configuration (→ p. 166 – 10.3 Station configurations).

Note that the processing time shown for each protocol is the sum of the step time and drip time for each step plus the total fill and drain time. The step time and drip time is shown for each step in a protocol; the fill and drain time is not.

Biopsy xylene

- Pre-defined standard protocol “Biopsy Xylene” for all biopsies with a diameter of up to 3 mm.
- Carryover setting: 75 (standard cassettes with biopsy pads)

Step	Reagent type	Time (min)	Temp (°C)	P/V	Stirrer	Drip time (s)
1	Formalin	1	Ambient	Ambient	On	10
2	Ethanol	1	Ambient	Ambient	On	10
3	Ethanol	1	Ambient	Ambient	On	10
4	Ethanol	1	Ambient	Ambient	On	10
5	Ethanol	1	Ambient	Ambient	On	10
6	Ethanol	15	45	Ambient	On	10
7	Ethanol	50	45	Ambient	On	10
8	Xylene	1	Ambient	Ambient	On	10
9	Xylene	5	Ambient	Ambient	On	10
10	Xylene	35	45	Ambient	On	10
11	Paraffin	5	65	Vacuum	On	10
12	Paraffin	10	65	Vacuum	On	10
13	Paraffin	25	65	Vacuum	On	10
Processing time:		3hr 11min				

Overnight xylene

- Pre-defined standard protocol "Overnight Xylene" for all routine tissues up to 20 × 10 × 4mm, except brain tissues and exceptionally thick fatty tissues.
- Carryover setting: 25 (standard cassettes without tissue carrier materials)

Step	Reagent type	Time (min)	Temp (°C)	P/V	Stirrer	Drip time (s)
1	Formalin	44	45	Ambient	On	10
2	Ethanol	30	45	Ambient	On	10
3	Ethanol	30	45	Ambient	On	10
4	Ethanol	30	45	Ambient	On	10
5	Ethanol	30	45	Ambient	On	10
6	Ethanol	60	45	Ambient	On	10
7	Ethanol	90	45	Ambient	On	10
8	Xylene	45	45	Ambient	On	10
9	Xylene	45	45	Ambient	On	10
10	Xylene	90	45	Ambient	On	10
11	Paraffin	60	65	Vacuum	On	10
12	Paraffin	60	65	Vacuum	On	10
13	Paraffin	80	65	Vacuum	On	10
Processing time:		12hr 14min				

Biopsy xylene fast protocol (recommended)

- The recommended protocol "Biopsy xylene fast protocol" is for punch biopsy (inc. fatty) at a size of ≤2 mm(diameter) × 4 mm(length).
- Carryover setting: 100 (standard cassettes with biopsy pads)

Step	Reagent type	Time (min)	Temp (°C)	P/V	Stirrer	Drip time (s)
1	Formalin	1	Ambient	Ambient	On	10
2	Ethanol	1	Ambient	Ambient	On	10
3	Ethanol	1	Ambient	Ambient	On	10
4	Ethanol	1	Ambient	Ambient	On	10
5	Ethanol	1	Ambient	Ambient	On	10
6	Ethanol	1	Ambient	Ambient	On	10
7	Ethanol	18	45	Ambient	On	10
8	Xylene	1	Ambient	Ambient	On	10
9	Xylene	1	Ambient	Ambient	On	10
10	Xylene	14	45	Ambient	On	10
11	Paraffin	2	65	Vacuum	On	10
12	Paraffin	1	65	Vacuum	On	10
13	Paraffin	14	65	Vacuum	On	10
Processing time:		1hr 25min				

Xylene-free Protocols

All the xylene-free protocols below are designed for use with the xylene-free bottle configuration in Station Configurations (→ p. 166 – 10.3 Station configurations).

Note that the processing time shown for each protocol is the sum of the step time and drip time for each step plus the total fill and drain time. The step time and drip time is shown for each step in a protocol; the fill and drain time is not.

Biopsy xylene-free

- Pre-defined xylene-free protocol “Biopsy Xylene-free” for all biopsies with a diameter up to 3 mm.
- Carryover setting: 75 (standard cassettes with biopsy pads)

Step	Reagent type	Time (min)	Temp (°C)	P/V	Stirrer	Drip time (s)
1	Formalin	1	Ambient	Ambient	On	10
2	85% Ethanol	1	Ambient	Ambient	On	10
3	85% Ethanol	15	55	Ambient	On	10
4	80/20Ethanol/IPA	5	Ambient	Ambient	On	10
5	80/20Ethanol/IPA	35	55	Ambient	On	10
6	IPA	1	Ambient	Ambient	On	10
7	IPA	1	Ambient	Ambient	On	10
8	IPA	40	55	Ambient	On	10
11	Paraffin	30	85	Vacuum	On	10
12	Paraffin	12	85	Vacuum	On	10
13	Paraffin	5	65	Vacuum	On	10
Processing time:		2hr 59min				

Overnight xylene-free

- Pre-defined xylene-free protocol “Overnight Xylene-free” for all routine tissues up to 20 × 10 × 4mm, except brain tissues and exceptionally thick fatty tissues.
- Carryover setting: 26 (standard cassettes without tissue carrier materials)

Step	Reagent type	Time (min)	Temp (°C)	P/V	Stirrer	Drip time (s)
1	Formalin	68	55	Ambient	On	10
2	85% Ethanol	30	55	Ambient	On	10
3	85% Ethanol	40	55	Ambient	On	10
4	80/20Ethanol/IPA	50	55	Ambient	On	10
5	80/20Ethanol/IPA	90	55	Ambient	On	10
6	IPA	30	55	Ambient	On	10
7	IPA	60	55	Ambient	On	10
8	IPA	120	55	Ambient	On	10
11	Paraffin	80	85	Vacuum	On	10
12	Paraffin	70	85	Vacuum	On	10
13	Paraffin	60	65	Vacuum	On	10
Processing time:		12hr 11min				

10.2.4 Cleaning protocol

Quick clean

- Pre-defined cleaning protocol “Quick Clean”.
- Bottle configuration: one bottle each of cleaning solvent and cleaning ethanol.
- Never run a cleaning protocol while tissue is in the retort, as the dry step will damage the tissue.

Step	Reagent group	Time (min)	Temp (°C)	P/V	Stirrer	Drip time (s)
1	Cleaning solvents	12	75	Ambient	On	10
2	Cleaning ethanol	6	55	Ambient	On	10
3	Dry step	12	80	N/A	Off	N/A
Processing time:		38				

10.3 Station configurations

Use the station configurations in this section for the protocols.

If considering alternative station configurations, remember to take into account how you will configure your protocols, including the reagent selection method ([→ p. 91 – 6.1.2 Reagent selection method](#)). For example, some laboratories use explicitly graded ethanol with reagent types identified as “Ethanol 70%”, “Ethanol 90%”, etc. This sort of station configuration requires that protocols use type (or station) selection, and the protocols must be configured to use the ethanol grades in the correct order.

Xylene configuration

This is the suggested station configuration when running xylene protocols. See note below for special conditions for initial bottle setup and when doing a complete change of all ethanol bottles.

Station	Reagent
S1	Formalin
S2	Formalin
S3	Ethanol (70%)*
S4	Ethanol (90%)*
S5	Ethanol
S6	Ethanol
S7	Ethanol
S8	Ethanol
S9	Ethanol
S10	Ethanol
S11	Ethanol
S12	Xylene
S13	Xylene
S14	Xylene
S15	Xylene
S16	Cleaning xylene
S17	Cleaning Ethanol
W1	Paraffin
W2	Paraffin
W3	Paraffin
W4	Paraffin

*All ethanol dehydrants after fixative should be labeled and named in the software "Ethanol". However, if setting up bottles on a new instrument or replacing all the ethanol bottles at once, the first and second bottles should be filled with 70% and 90% ethanol respectively. As operation continues and you are prompted to replace degraded bottles, replace with 100% ethanol. Other, initially higher-concentration bottles will have degraded, so there will always be at least one bottle at a low concentration.

Xylene-free configuration

This is the suggested station configuration when running xylene-free protocols. See the note below the table for special conditions that apply to the initial bottle setup and when replacing all the 85% ethanol bottles at once.

Station	Reagent
S1	Formalin
S2	Formalin
S3	85% Ethanol*
S4	85% Ethanol*
S5	85% Ethanol
S6	85% Ethanol
S7	80/20 Ethanol/IPA
S8	80/20 Ethanol/IPA
S9	80/20 Ethanol/IPA
S10	IPA
S11	IPA
S12	IPA
S13	IPA
S14	Cleaning xylene
S15	Cleaning xylene
S16	Cleaning Ethanol
S17	Cleaning Ethanol
W1	Paraffin
W2	Paraffin
W3	Paraffin
W4	Paraffin

*All ethanol dehydrants after fixative should be labeled and named in the software "85% Ethanol". However, if setting up bottles on a new instrument or replacing all the ethanol bottles at once, the first two bottles should be filled with 70% ethanol (but still be named "85% Ethanol"). As operation continues and you are prompted to replace degraded bottles, replace with 85% ethanol. Other, initially higher-concentration bottles will have degraded, so there will always be at least one bottle at a low concentration.

10.4 Protocol Step temperatures

The tissue processor uses five protocol types to accommodate different types of processing. Each type has a set of reagent compatibility sequences that comply with the intended use (→ p. 169 – 10.5 Reagent compatibility tables). The allowable temperature range for each step is also dependent on the protocol type. The following sections list the protocol temperature ranges and typical protocol sequences.

Protocol type	Retort temp. range for reagent	Retort temp. range for paraffin
Standard	35 °C to 65 °C	58°C to 77 °C
Xylene-free	35 °C to 65 °C	58°C to 77 °C
Cleaning	35 °C to 85 °C	N/A

10.5 Reagent compatibility tables

The reagent compatibility tables determine the allowable reagent sequences. The sequences vary depending on the operation or protocol type.

Manual operation

Current Step	Previous Step										
	None	Fixatives	Processing Water	Dehydrants	IPA	Defat	Post Defat	Clearers	Paraffin	Cleaning Solvents	Cleaning Ethanol
Y = Compatible											
Fixatives	Y	Y	Y	Y							Y
Processing Water	Y	Y	Y	Y							Y
Dehydrants	Y	Y	Y	Y	Y	Y		Y		Y	Y
IPA	Y				Y						
Defat	Y			Y		Y		Y		Y	Y
Post Defat	Y			Y		Y	Y	Y		Y	Y
Clearers	Y			Y		Y	Y	Y		Y	Y
Paraffin	Y				Y			Y	Y	Y	
Cleaning Solvents	Y			Y	Y	Y	Y	Y	Y	Y	Y
Cleaning Ethanol	Y	Y	Y	Y	Y	Y	Y	Y		Y	Y

Standard processing

Current Step	Previous Step							
Y = Compatible	None	Fixatives	Processing Water	Dehydrants	Defat	Post Defat	Clearers	Paraffin
Fixatives	Y	Y	Y					
Processing Water	Y	Y	Y					
Dehydrants	Y	Y	Y	Y				
Defat	Y			Y	Y			
Post Defat	Y			Y	Y	Y		
Clearers	Y			Y	Y	Y	Y	
Paraffin	Y						Y	Y

Cleaning protocol

Current Step	Previous Step										
Y = Compatible	None	Fixatives	Processing Water	Dehydrants	IPA	Defat	Post Defat	Clearers	Paraffin	Cleaning Solvents	Cleaning Ethanol
Cleaning Solvents	Y			Y	Y	Y	Y	Y	Y	Y	Y
Cleaning Ethanol	Y	Y	Y	Y	Y	Y	Y	Y		Y	Y

Standard reverse processing (purpose to remove paraffin)

Current Step	Previous Step							
Y = Compatible	Cleaning Solvents	Cleaning Ethanol	None	Dehydrants	Defat	Post Defat	Clearers	Paraffin
Cleaning Solvents	Y		Y					Y
Cleaning Ethanol	Y	Y	Y					
Dehydrants		Y	Y	Y				
Defat		Y	Y	Y	Y			
Post Defat		Y	Y	Y	Y	Y		
Clearers		Y	Y	Y	Y	Y	Y	
Paraffin			Y				Y	Y

Xylene-free processing

Current Step	Previous Step					
Y = Compatible	None	Fixatives	Processing Water	Dehydrants	IPA (Group)	Paraffin
Fixatives	Y	Y	Y			
Processing Water	Y	Y	Y			
Dehydrants	Y	Y	Y	Y		
IPA (Group)	Y			Y	Y	
Paraffin	Y				Y	Y

*Reagent type will be selected during creating processing protocol in xylene-free mode.

Xylene-free reverse processing (purpose to remove paraffin)

Current Step	Previous Step					
Y= Compatible	Cleaning Solvents	Cleaning Ethanol	None	Dehydrants	IPA (Group)	Paraffin
Cleaning Solvents	Y		Y			Y
Cleaning Ethanol	Y	Y	Y			
Dehydrants		Y	Y	Y		
IPA (Group)		Y	Y	Y	Y	
Paraffin			Y		Y	Y

11. Troubleshooting

11.1 Preliminary questions

When faced with blocks that are difficult to section, first collect as much information as possible to assist in analyzing the problem. Some questions to ask are:

1. Did the instrument software indicate an error in the run? Instrument warnings and alarms will be displayed on screen and in the event log.
2. Was there anything different about the run that produced the problem specimens compared to previous successful runs, e.g. a recently changed reagent bottle?
3. Is there a possibility that an error was made when replacing reagents on the processor? Check that the correct reagent is in each bottle.
4. The Reagent Stations screen records reagent concentrations. It also shows how many cassettes have been put through a reagent and how many cycles have used the reagent since the reagent was last changed. Check if these are correct.
5. Are any reagents over their recommended purity thresholds?
6. Was the intended processing protocol actually used? For example, is it possible that specimens intended for a longer processing protocol were placed on a shorter processing protocol?
7. Were the specimens processed using the usual protocol for specimens of this size and type, and that generally produces good results? If so, the problem is probably not in the protocol parameters.
8. Were the specimens at the very top of the retort? Were the baskets placed in the retort correctly?
9. Were all the specimens in the batch affected, or just some of them? Were all the specimens of a similar type? Were they all from the same source? Answers to these questions may indicate a problem prior to tissue processing.
10. Was normal fixation applied to the problem specimens?

These questions should help you determine what has gone wrong. If you remain uncertain as to the cause of the problem, you should gather as much information as possible by carefully examining the specimens. Close examination of the blocks can confirm what you suspect may have happened. Microscopic examination will also provide valuable information as to what may have gone wrong.

11.2 Flowcharts

This section has eight flowcharts, one for each of the different processing problems.

- Under-processed tissue – Instrument Setup
- Over-processed tissue – Instrument Setup
- Under- or over-processed tissue – Reagents
- Poor processing – Incorrect protocol
- Poor processing – Correct protocol
- Cutting artifact
- Staining artifact
- Block artifact

11.2.1 Under-processed tissue – Instrument Setup

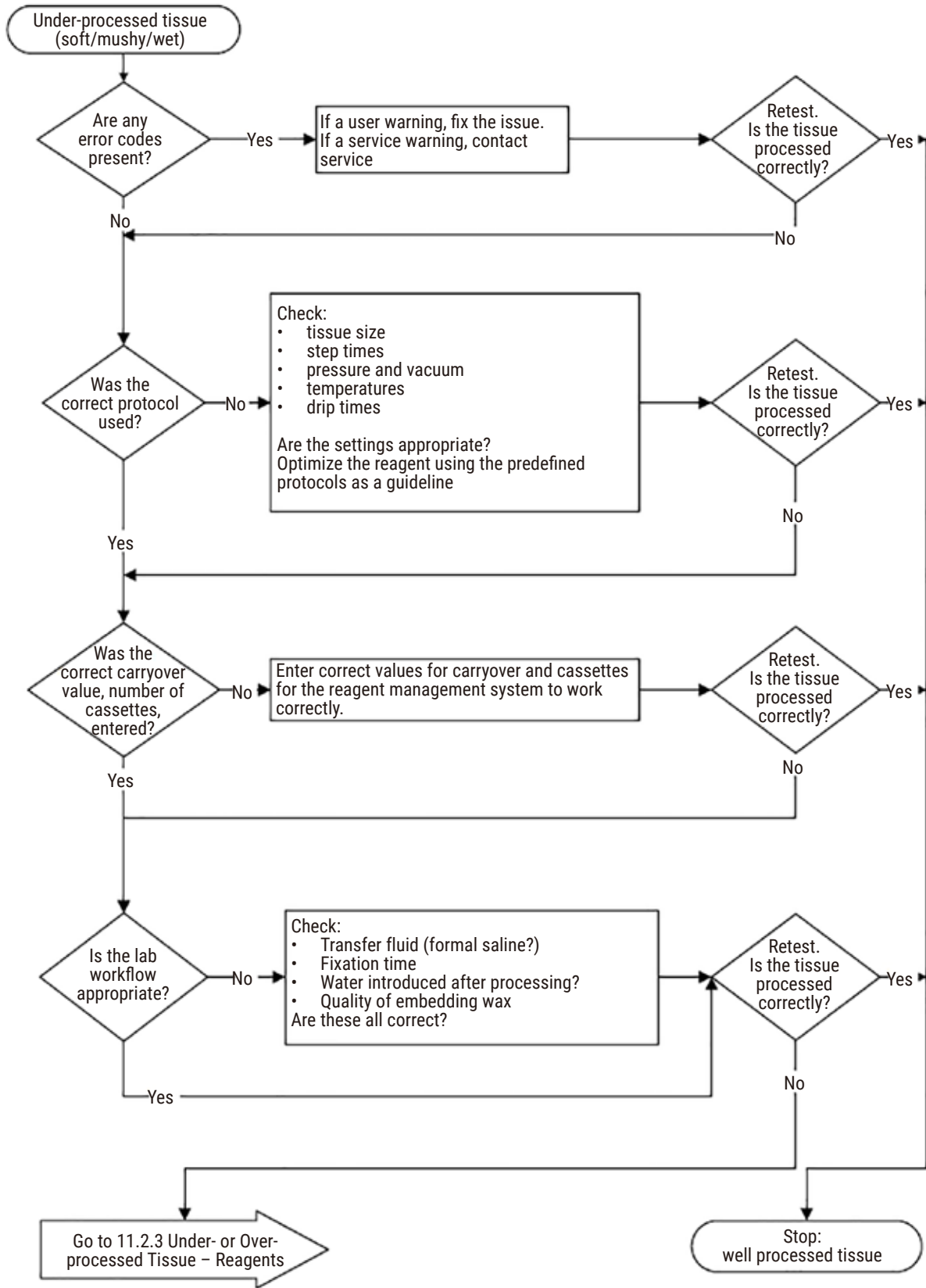

Fig. 105

11.2.2 Over-processed tissue – Instrument Setup

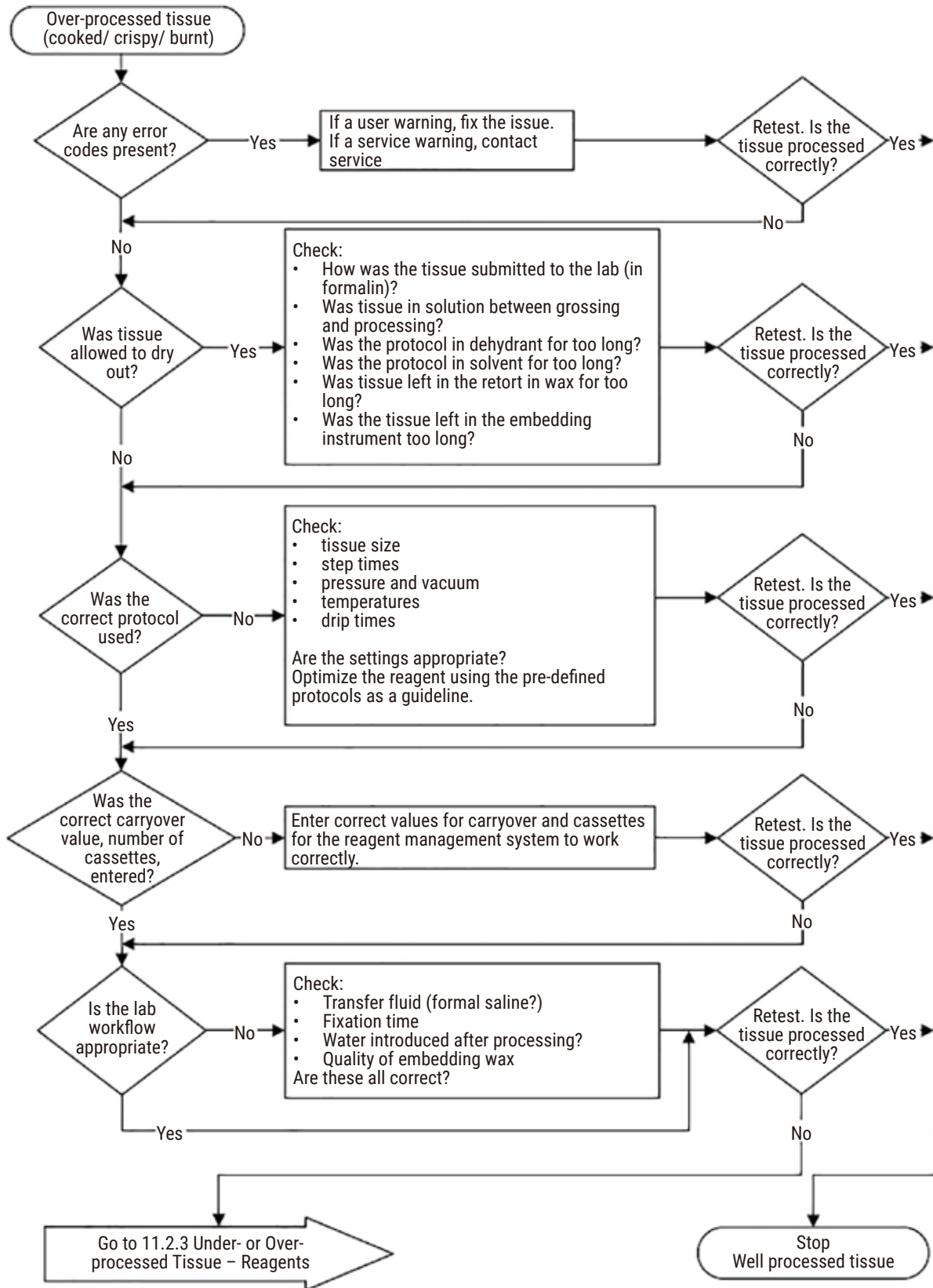

Fig. 106

11.2.3 Under- or Over-processed issue – Reagents

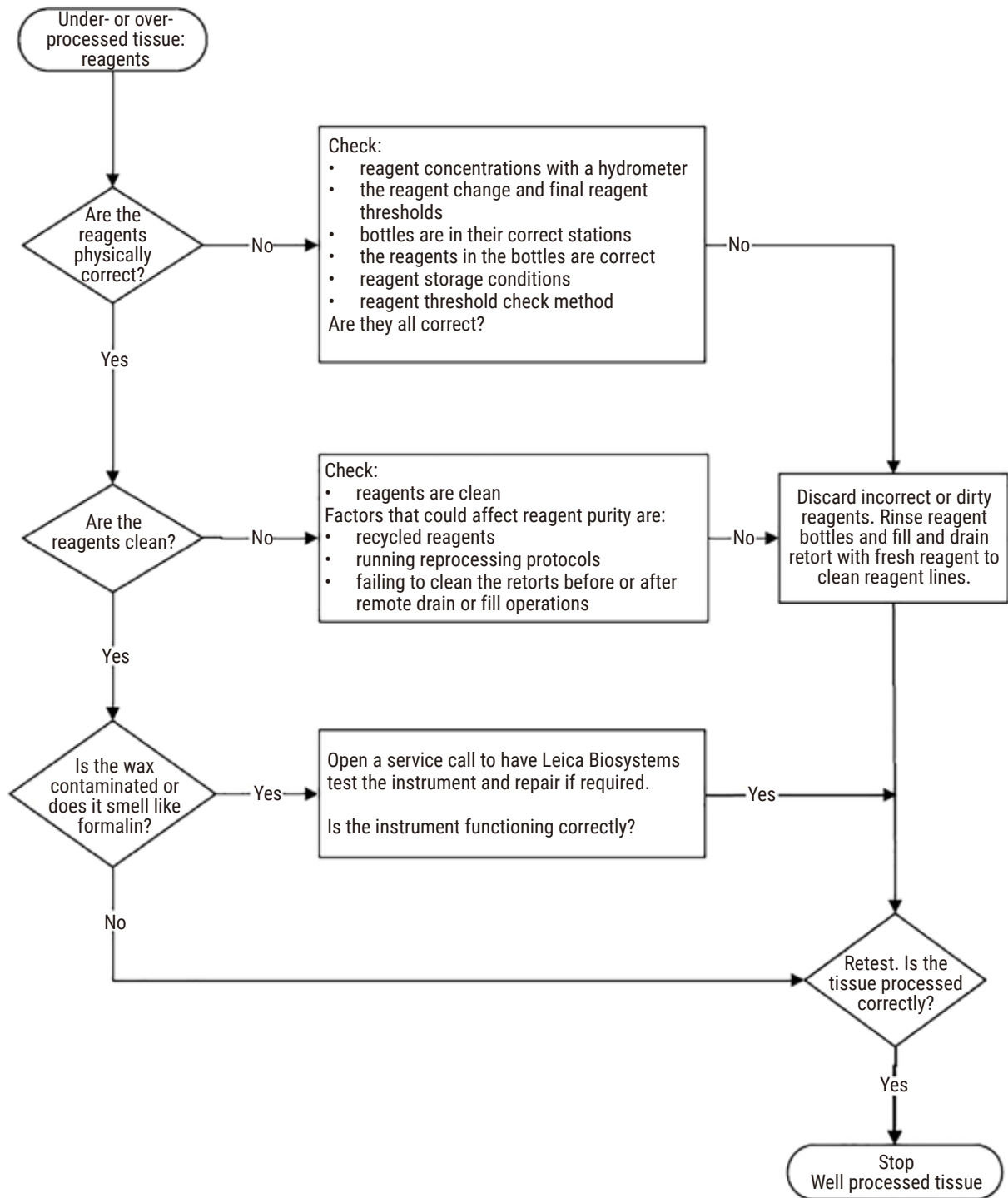

Fig. 107

11.2.4 Poor processing – Incorrect protocol

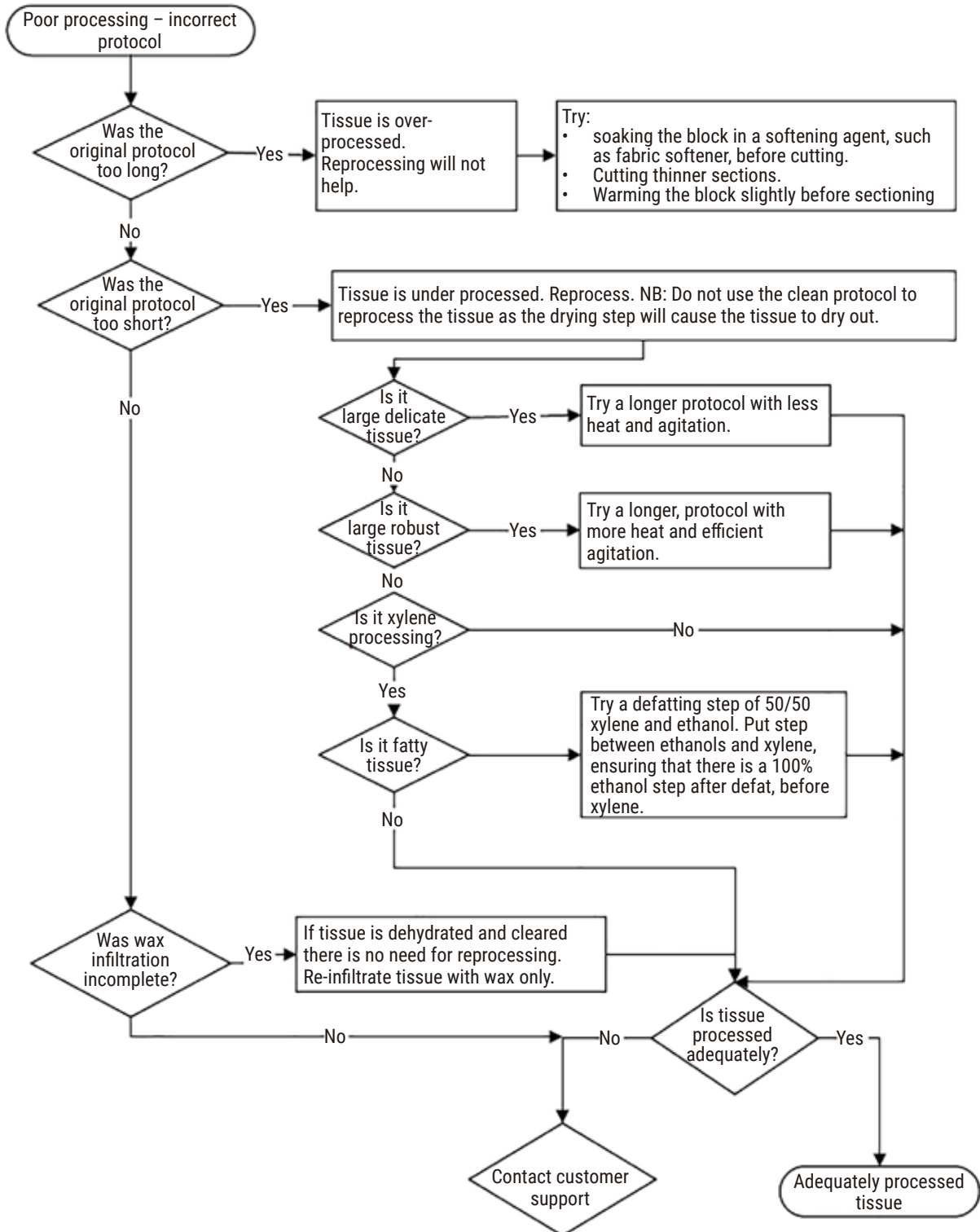

Fig. 108

11.2.5 Poor processing – Correct protocol

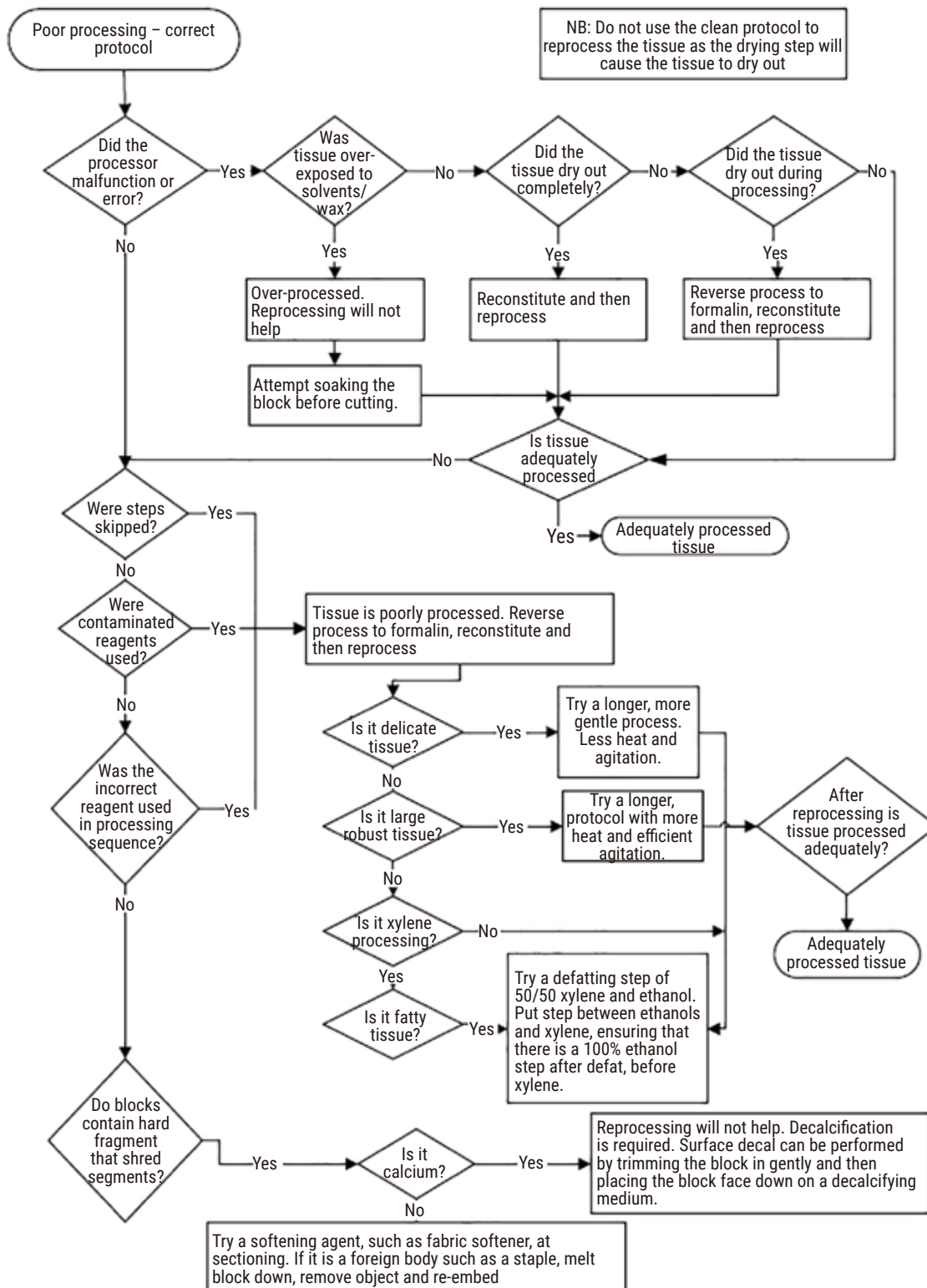

Fig. 109

11.2.6 Cutting artifact

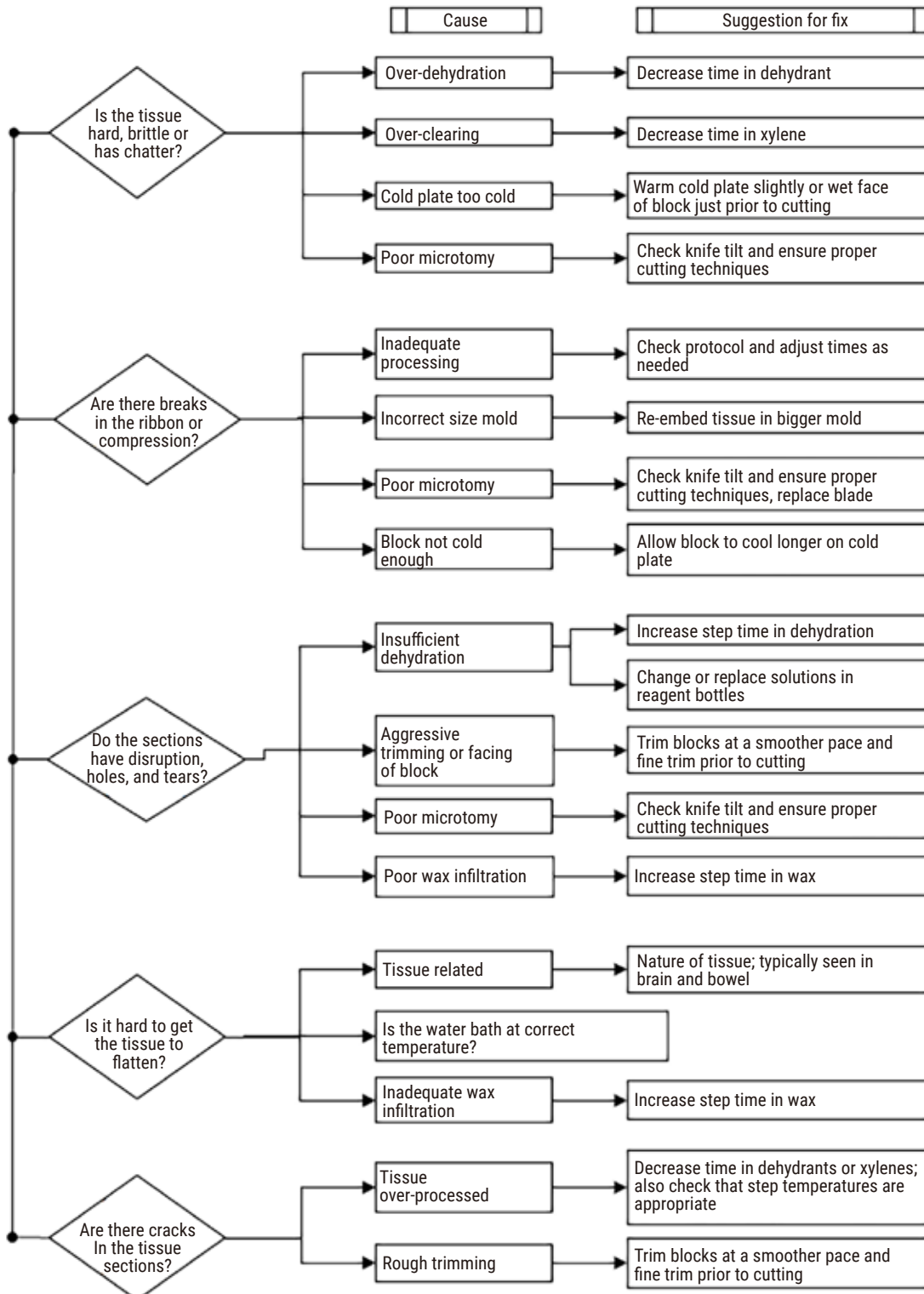

Fig. 110

11.2.7 Staining artifact

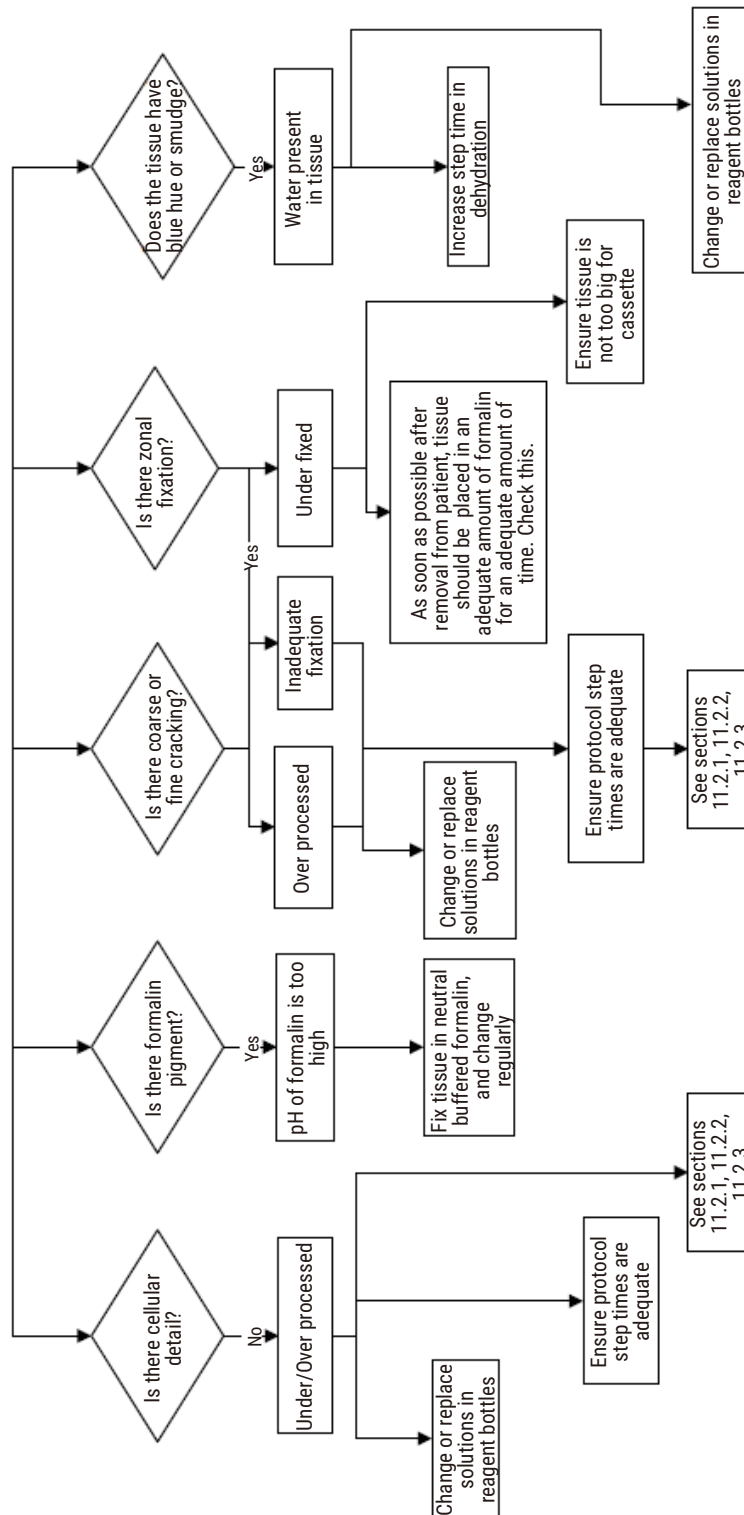

Fig. 111

11.2.8 Block artifact

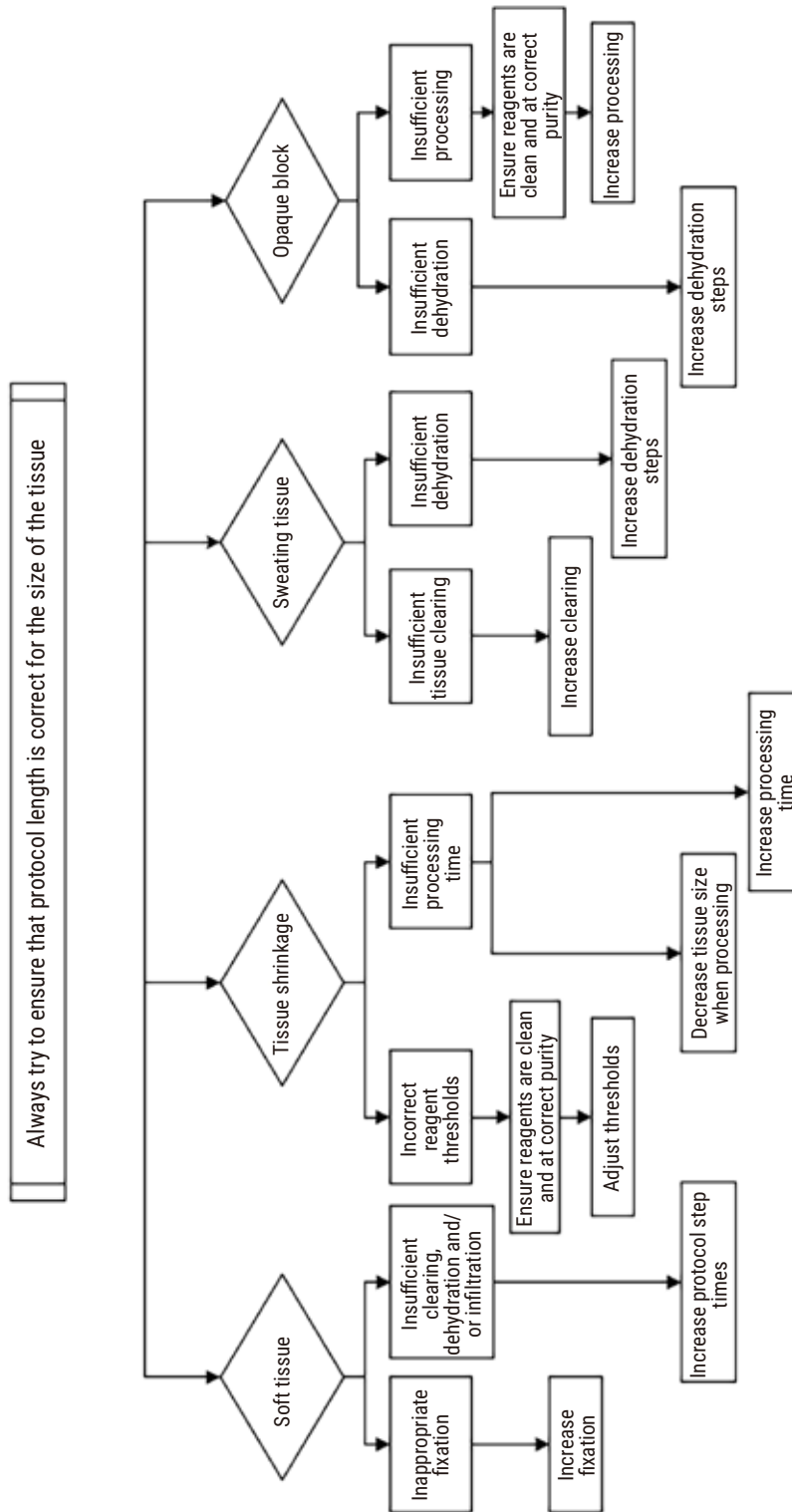

Fig. 112

11.2.9 Reprocessing recommendations

Not all problem tissue requires reprocessing. Some common problems and possible solutions are discussed in this section.

1. Tough, brittle, over-processed tissue

Treat the surface of the exposed tissue in the block with a rehydrating or softening agent, such as:

- Melting ice
- 0.2% aqueous Teepol™ or other wetting agent
- Fabric softener at 5% (e.g. Downy™)
- Mollifex™
- 9% glycerol in 60% ethanol

Treat for a few minutes, rinse, rechill and recut.

Reprocessing is inappropriate because it will cause further over-processing.

2. Gritty tissue due to calcium deposits

Treat the surface of the exposed tissue in the block with a decalcifying agent for 15–30 minutes. (The time depends on the decalcifier used.) Rinse to remove acid, rechill and recut.

Reprocessing tissue that contains calcium or other mineral deposits does not improve its cutting qualities. The calcium must be removed.

3. Hard shriveled tissue – dried out before paraffin infiltration

Soak in a large volume of reconstitution solution for 2–24 hours. (The time depends on the size and nature of the tissue and the severity of drying.) Reconstitution solutions include:

- Neutral buffered formalin
- Isotonic saline
- Sandison's solution
 - a. 50 mL 1% aqueous formalin
 - b. 30 mL 96% ethanol
 - c. 20 mL 5% sodium carbonate
- Ethanol-glycerol
 - a. 90 mL 60% ethanol
 - b. 10 mL glycerol

Then process the tissue normally.

4. Hard shriveled tissue – dried out but processed through to paraffin

Remove paraffin and rehydrate as detailed in problem 6, below. Apply a reconstitution solution as described in problem 3.

5. Tissue insufficiently infiltrated with paraffin

Place the cassettes back into the paraffin bath with vacuum, stirrer on and temperature at 65 ° C. This may be necessary when tissue has been prematurely removed from the paraffin.

6. Adequately fixed under-processed tissue

This problem can be due to too short a protocol, too large a specimen, or processor failure. Four solutions are recommended, but first identify the problem and rectify it. Test your fix by running control tissue through the processor before reprocessing the patient tissue (or use another processor).

Note: For the following solutions, first melt the blocks, blot off excess paraffin, and then place the specimens in new cassettes. This minimizes paraffin contaminating the processing reagents.

A. Taggart's method

Place the cassettes into a beaker of isotonic saline (aqueous solution of 0.9% sodium chloride) in an incubator at 65 °C for 1 hour. The paraffin rises to the surface. Remove the tissue and reprocess from formalin using a protocol suitable for its size and nature ([→ p. 162 – 10.2.1 Specimen type and protocol duration](#)).

The saline gently rehydrates the tissue, which can then be processed normally. Saline is a non-toxic reagent that can be safely used in an open laboratory.

B. Rapid reverse process

Process using a fast modified cleaning protocol ([→ p. 183 – Rapid reverse cleaning protocol](#)). Do not use the default Quick Clean protocol or protocols derived from this, because they finish with a drying step that will damage the tissue. After the cleaning protocol, reprocess from formalin using a schedule suitable for the size and nature of the specimen ([→ p. 162 – 10.2.1 Specimen type and protocol duration](#)).

Processor cleaning reagents provide a convenient automated method for removing paraffin and taking the tissue back to ethanol. However, it is a potentially harsher method than methods A or C.

C. Slow reverse process

Process using a modified cleaning protocol for a period equal to the time required to forward-process the tissue (→ p. 184 – [Slow reverse cleaning protocol](#)). Then reprocess from formalin using a schedule suitable for the size and nature of the specimen (→ p. 162 – [10.2.1 Specimen type and protocol duration](#)).

A long reverse process is very gentle on the tissue. If time permits, this is the favored option.

7. Tissue affected by formalin during clearing or paraffin infiltration

This problem can occur if a leaking valve allows formalin to flow into the paraffin bath. If you see this problem, contact customer support and request that your instrument be tested.

Formalin contamination is characterized by blue hue in the nuclei, loss of chromatin detail, nuclear shrinkage, variable eosinophilia and cytoplasmic swelling and/or shrinkage.

First melt the blocks, blot off excess paraffin, and then place the specimens in new cassettes. This minimizes paraffin contaminating the processing reagents. Then reverse-process the blocks by any of the methods listed for problem 6. After this, soak in a high pH Tris-HCl retrieval solution (e.g. Leica BOND Epitope Retrieval Solution 2) for 2–12 hours at room temperature.

This treatment improves the staining qualities of the H&E, the cutting qualities of the tissue and the cohesiveness of the section. Nuclear detail, cytoplasmic swelling and definition are unlikely to improve.

8. Inadequately fixed, under-processed tissue

A possible remedy is to slowly reverse-process the tissue (→ p. 183 – [C. Slow reverse process](#)), apply additional formalin fixation, then reprocess using a schedule suitable for the size and nature of the specimen (→ p. 162 – [10.2.1 Specimen type and protocol duration](#)).

Unfixed or poorly-fixed tissue is damaged by processing. The ethanol and high temperatures exert a fixative effect different to that of formaldehyde. As a result, blocks become more susceptible to hardening and shrinkage. When combined with under-processing, blocks may be unusable.

Rapid reverse cleaning protocol

Step	Reagent type	Time (min)	Temp (°C)	P/V	Stirrer	Drip time (s)
1	Cleaning solvents	12	65	Ambient	On	10
2	Cleaning ethanol	6	55	Ambient	On	10
Processing time:		18				

11 Troubleshooting

Slow reverse cleaning protocol

Step	Reagent type	Time (min)	Temp (°C)	P/V	Stirrer	Drip time (s)
1	Cleaning solvents	60	65	Ambient	On	10
2	Cleaning solvents	60	65	Ambient	On	10
3	Cleaning ethanol	60	45	Ambient	On	10
4	Cleaning ethanol	60	45	Ambient	On	10
Processing time:		240				

11.3 Power failure

If there is evidence of a power failure to the instrument, check for error messages indicating the nature of the problem after the power is restored. Follow the instructions on the screen to handle the specimens.

11.4 Crash or freeze of master software

If there is evidence of crash or freeze of master software, check for error messages indicating the nature of the problem after the instrument is restarted. Follow the instructions on the screen to handle the specimens.

12. Ordering Information

Part description	Order No.
HistoCore I-Scan kits	14 0488 60946
Basket hook	14 0488 58177
Cassette basket	14 0488 58160
Blue clip sets with datamatrix	14 0488 58176
Black clip sets with datamatrix	14 0488 58173
Printed barcode stickers	14 0488 60133
Reagent bottle assembly	14 0488 57899
Paraffin bath vent plug	14 0488 58088
Exhaust Interface	14 0493 53387
Active carbon filter	14 0488 58136
Remote fill/drain tube for reagents	14 0488 60134
Remote drain tube for paraffin	14 0488 60135
Paraffin scraper	14 0393 53643
Molykote 111 grease, 100g	14 0336 35460
O-Ring	14 0493 51361
Set of adhesive labels for bottles	14 048860131
Set of adhesive number labels for bottle	14 0488 60148
Accessory pocket assy	14 0488 60153
Cross-connector 21.85*5 mm	14 6000 05407
Drip tray	14 0488 59324
Level sensor brush	14 0488 58099
Bumper	14 0488 59321
M4x8 EN ISO 7380	14 3000 00065
M6x35 ISO4762 fully thread	14 3000 00537
Straight Screwdriver	14 0488 60138
Ratchet spanner 17mm	14 0488 60142
Exhaust tube	14 0422 31975
Opener reagent bottle cap	14 0488 78224
Bottle Cap Assembly	14 0488 78231
Level sensor brush	14 0488 58099

A1. Decontamination Confirmation

Any product that is to be returned to Leica Biosystems or serviced on site must be properly cleaned and decontaminated. Please find the dedicated template for confirming decontamination by using the search function on our website at www.LeicaBiosystems.com. This template must be used to enter all required data.

If a product is returned, a copy of the completed and signed decontamination certificate must either be enclosed or handed over to a service technician. The user shall be responsible for products that are returned without a completed decontamination certificate or with a missing decontamination certificate. Return shipments that are classified by the company as a potential hazard source will be returned to the sender at his/her own expense and risk.

A2. Warranty and Service

Warranty

Leica Biosystems Nussloch GmbH guarantees that the contractual product delivered has been subjected to a comprehensive quality control procedure based on the Leica in-house testing standards, and that the product is faultless and complies with all warranted technical specifications and/or agreed-upon characteristics.

The scope of the warranty is based on the contents of the contract concluded. The warranty terms of your Leica sales organization or the organization from which you have purchased the contractual product shall apply exclusively.

Service information

If you are in need of technical customer support or spare parts, please contact your Leica representative or the Leica dealer where you purchased the instrument.

The following information about the instrument is required:

- Model name and serial number of the instrument.
- Location of the instrument and name of a contact person.
- Reason for the service call.
- Date of delivery.



Warning

To prevent damage to the instrument and specimens, only those accessories and spare parts that have been authorized by Leica may be installed or used with the instrument.

Decommissioning and disposal

The instrument or parts of the instrument must be disposed of according to existing applicable, local regulations.

Physical life

The physical life of the equipment is 7 years. Physical life of this product is determined according to actual situation after launching product in local market. Users have to maintain the product according to the requirements of the Instructions for Use and have to ensure that the product can be used safely and effectively.

www.LeicaBiosystems.com



Leica Biosystems Nussloch GmbH
Heidelberger Strasse 17 - 19
69226 Nussloch
Germany

Tel.: +49 - (0) 6224 - 143 0
Fax: +49 - (0) 6224 - 143 268
Web: www.LeicaBiosystems.com

